

Western Electric

252A Vacuum Tube

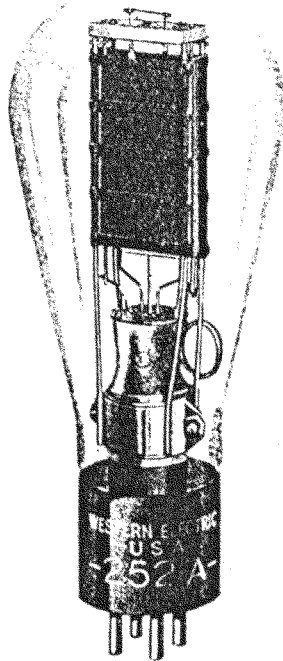

Classification—Moderate-power, filamentary triode

Applications—Audio-frequency amplifier where power outputs up to about 8 watts are required.

Oscillator

Modulator

Dimensions—Dimensions, outline diagrams of the tube and base, and the arrangement of the electrode connections to the base terminals are shown in Figures 1 and 2.

Base—Medium, four-pin thrust base with bayonet pin.

Socket—Standard, four-contact type such as the Western Electric 143B socket.

Mounting Positions—Either vertical or horizontal. If mounted in a horizontal position, the plane of the filament, as shown in Figure 2, should be vertical.

Average Direct Interelectrode Capacitances

Grid to plate.....	12.0 μf .
Grid to filament.....	6.5 μf .
Plate to filament.....	4.0 μf .

Filament Rating

Filament voltage.....	5.0 volts, a.c. or d.c.
Nominal filament current.....	2.0 amperes

The filament of this tube is designed to operate on a voltage basis and should be operated at as near the rated voltage as is practicable. When alternating current is used for heating the filament, the grid and plate returns should be connected to a center tap on the secondary of the filament transformer.

Characteristics—Plate current characteristics of a typical 252A tube are shown in Figure 3 as functions of grid voltage for a number of values of plate voltage. Similar characteristics as functions of plate voltage for several values of grid voltage are given in Figure 4. Amplification factor, plate resistance, and transconductance characteristics are shown in Figures 5, 6 and 7, respectively as functions of grid voltage for several values of plate voltage. All of these characteristics are for direct-current filament supply with the grid and plate returns connected to the negative end of the filament. With alternating-current filament supply, approximately the same characteristics are obtained if 3.0 is added to the numerical value of each grid bias.

Limiting Conditions for Safe Operation

Maximum plate voltage.....	500 volts
Maximum plate current for manually adjusted grid bias or self-biasing circuit.....	*90 milliamperes
Maximum plate current of average tube for fixed grid bias.....	**75 milliamperes
Maximum instantaneous grid potential on positive swing of input voltage.....	+10 volts

*Modified as indicated in Figure 3 for plate voltages between 425 and 500 volts.

**Except between plate voltages of 425 and 500 volts, where limits should be 15 milliamperes less than those indicated in Figure 3 for a given plate voltage.

Operating Conditions and Output—Permissible combinations of operating plate voltage and plate current are included within the area, ABCDE, in Figure 3. Amplification factor, plate resistance, transconductance, and performance data are listed in the table on page 3 for a number of typical operating conditions represented by selected points within this area. A less severe operating condition should be selected in preference to a maximum operating condition wherever possible. The life of the tube at maximum conditions may be shorter than at less severe conditions.

Where it is necessary to operate a 252A tube at or near a maximum permissible plate current, provision should be made for adjusting the grid bias of each tube independently so that the maximum safe plate current will not be exceeded in any tube. Alternatively, a self-biasing circuit may be used, in which the grid bias for each tube is obtained from the voltage drop produced by the plate current passing through a resistance. Where it is necessary to use a fixed grid bias, the plate current of the average tube should be limited to a value 15 milliamperes below the maximum safe plate current, so that tubes having plate currents higher than the average will not exceed the maximum rating.

The performance data include the fundamental power output and the second and third harmonic levels for the indicated values of load resistance and input voltage. The power output, P_m , is given in watts and the second and third harmonic levels, F_{2m} and F_{3m} , are given in decibels below the fundamental in each case. The peak value of the sinusoidal input voltage, E_{gm} , is numerically equal to the grid bias for each operating condition. For a smaller input voltage, E_g , the output and harmonic levels are given approximately by the following relations:

$$P = P_m \left(\frac{E_g}{E_{gm}} \right)^2$$

$$F_2 = F_{2m} + 20 \log_{10} \frac{E_{gm}}{E_g}$$

$$F_3 = F_{3m} + 40 \log_{10} \frac{E_{gm}}{E_g}$$

Curves showing the variation of power output and harmonic levels with load resistance for several values of operating plate current are shown in Figures 8, 9 and 10 for a plate voltage of 450 volts.

TABLE

Plate Voltage Volts	Grid Bias Volts	Plate Current Milli- amperes	Amplification Factor	Plate Resistance Ohms	Trans-conductance Micro- mhos	Input Voltage Peak Volts	Load Resistance Ohms	Out-put Power Watts	Second Har- monic db	Third Har- monic db
300	-45	19	5.08	2300	2250	45	8000	2.0	26	36
300	-40	31	5.14	1850	2800	40	4000	2.5	25	37
							5000	2.2	28	41
300	-35	46	5.20	1600	3300	35	2500	2.4	26	41
350	-50	30	5.10	1850	2700	50	6000	3.1	27	39
350	-45	45	5.16	1600	3200	45	3500	3.6	27	40
400	-60	29	5.08	1900	2650	60	8000	3.7	28	40
400	-55	44	5.12	1650	3100	55	2500	5.4	21	39
							4000	5.0	26	38
							5000	4.5	28	42
400	-50	60	5.18	1500	3500	50	2500	5.2	26	38
							3000	5.0	28	41
400	-45	78	5.20	1350	3850	45	1500	4.9	25	38
450	-70	30	5.06	1950	2600	70	8000	5.2	26	37
450	-65	44	5.10	1650	3050	65	5000	6.2	26	38
450	-60	60	5.14	1500	3450	60	3000	6.9	25	37
475	-70	43	5.10	1700	3050	70	6000	6.5	27	39
475	-65	59	5.14	1500	3450	65	4000	7.3	27	40
*450	-55	78	5.18	1350	3800	55	2500	6.8	27	41
*500	-75	43	5.08	1700	3050	75	6000	7.4	25	38
*500	-70	58	5.12	1500	3450	70	4000	8.3	26	38

*Maximum operating conditions.

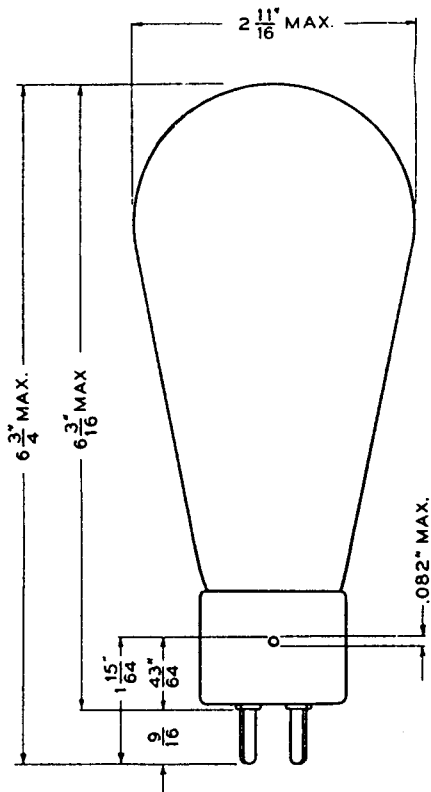

FIG. 1

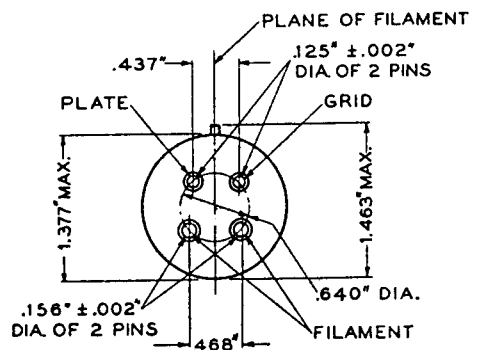

FIG. 2

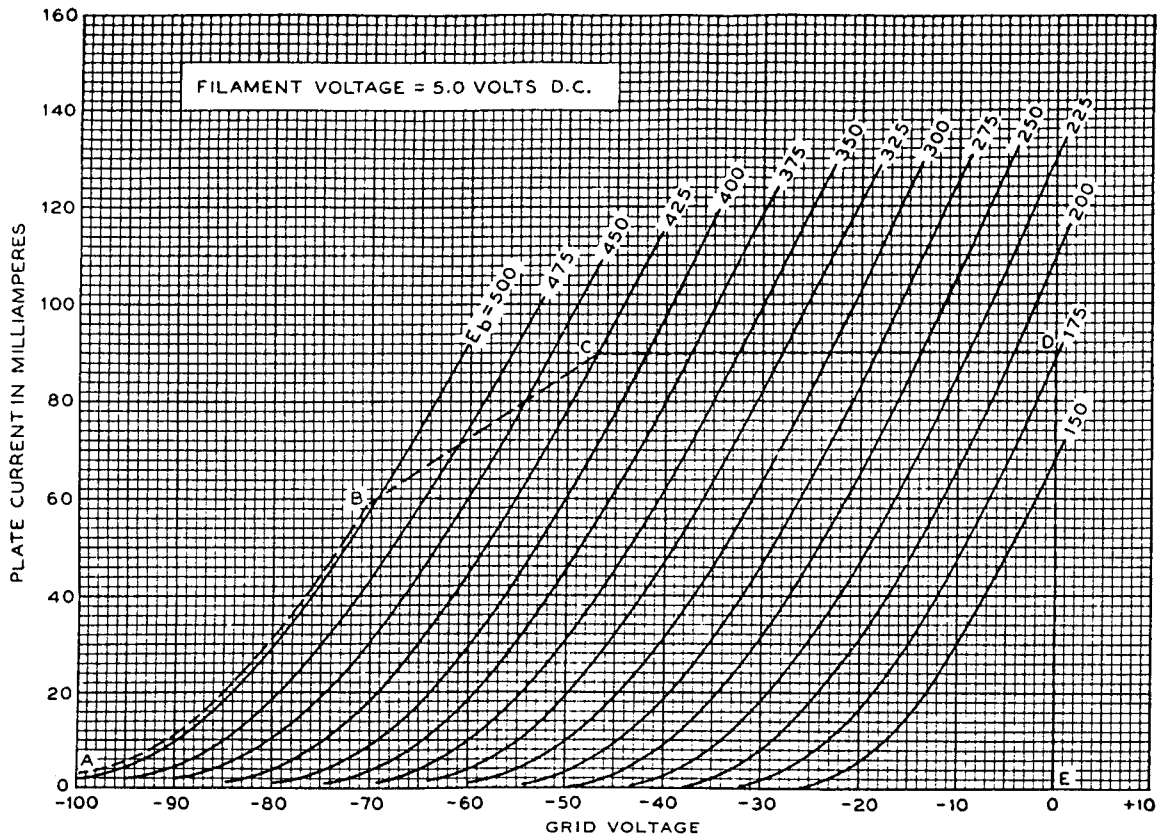

FIG. 3

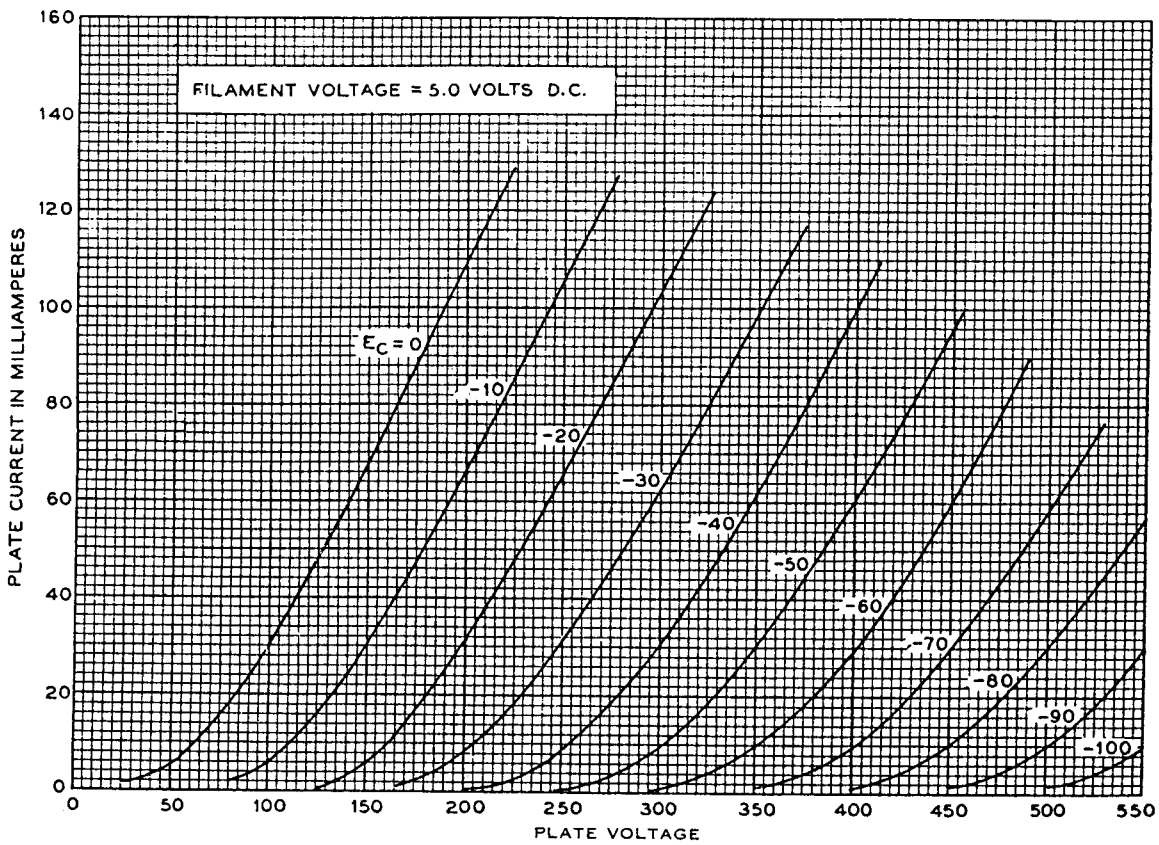

FIG. 4

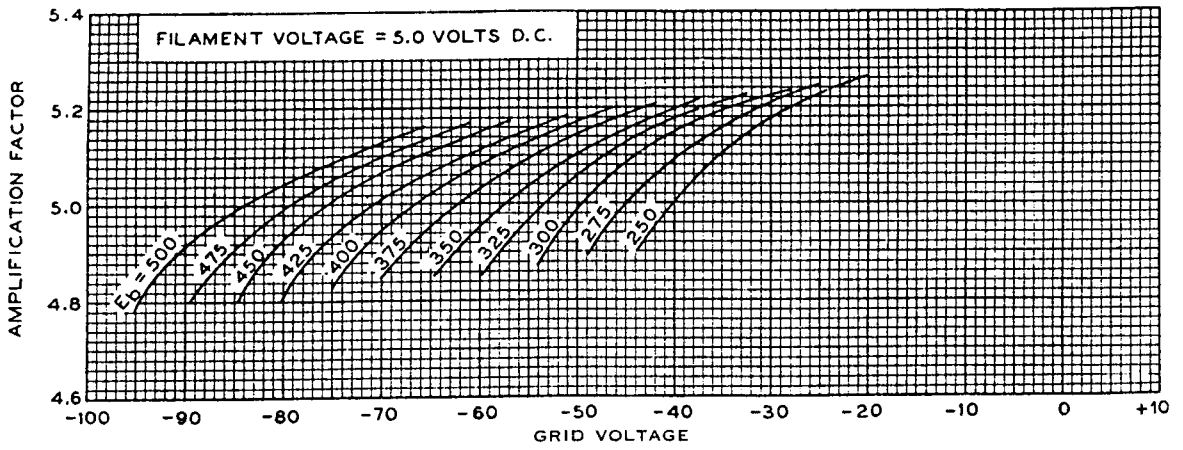

FIG. 5

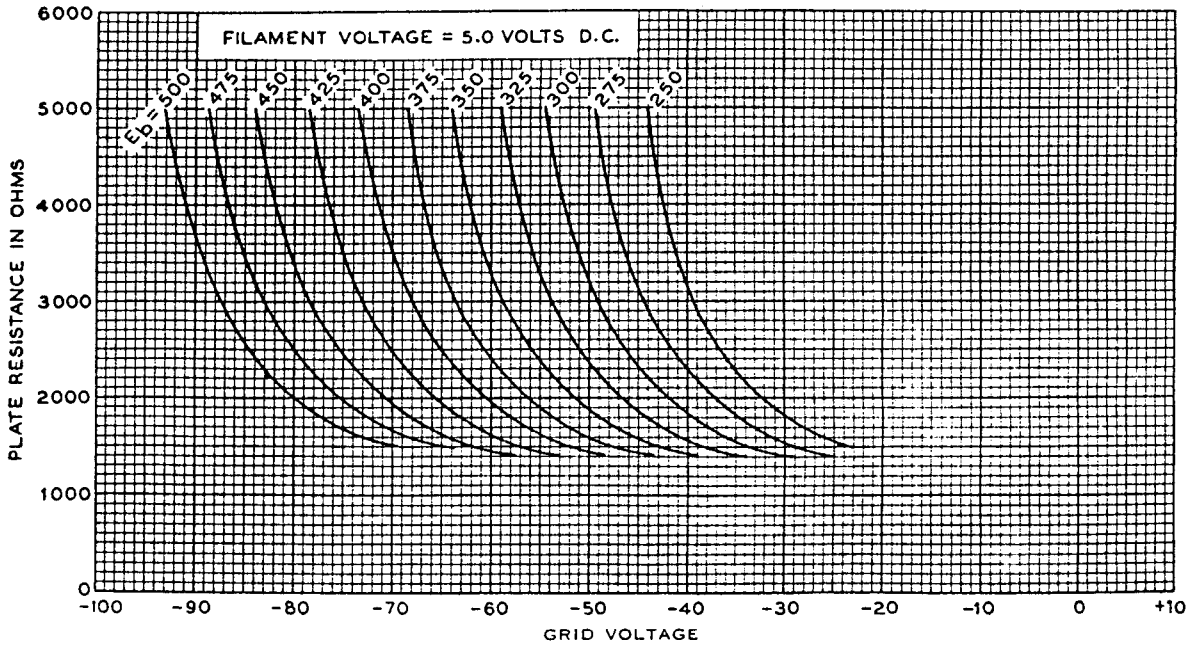

FIG. 6

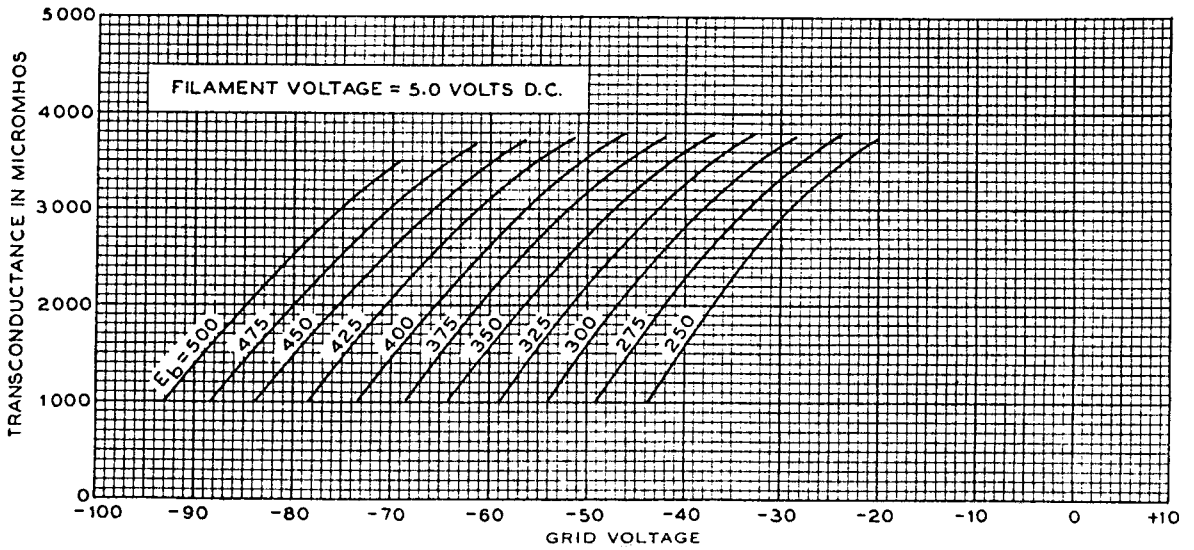

FIG. 7

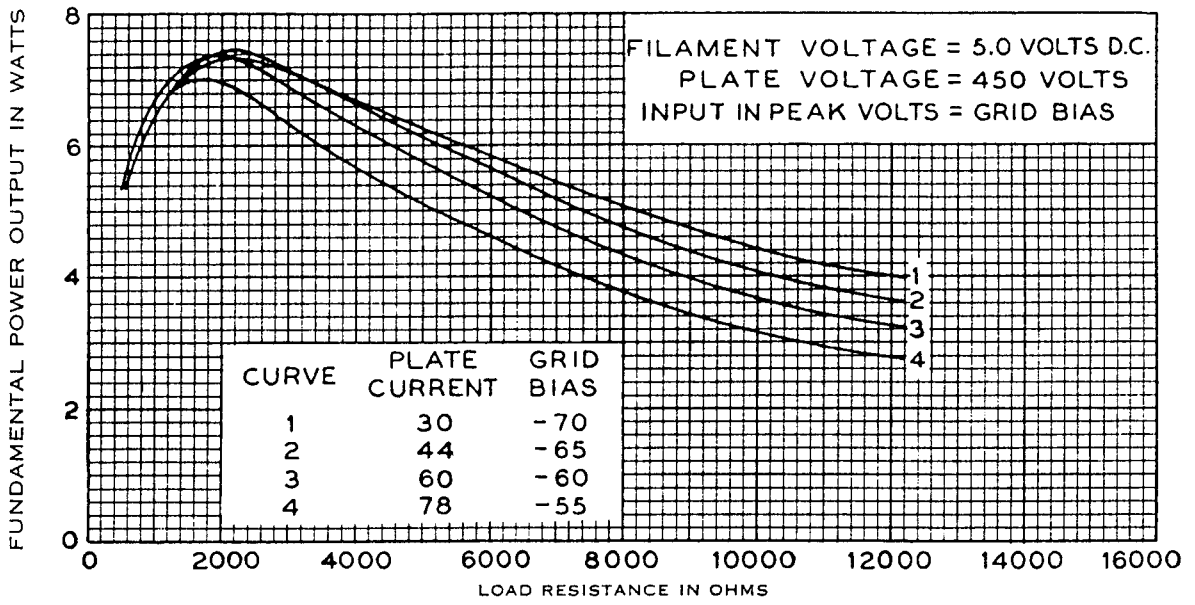

FIG. 8

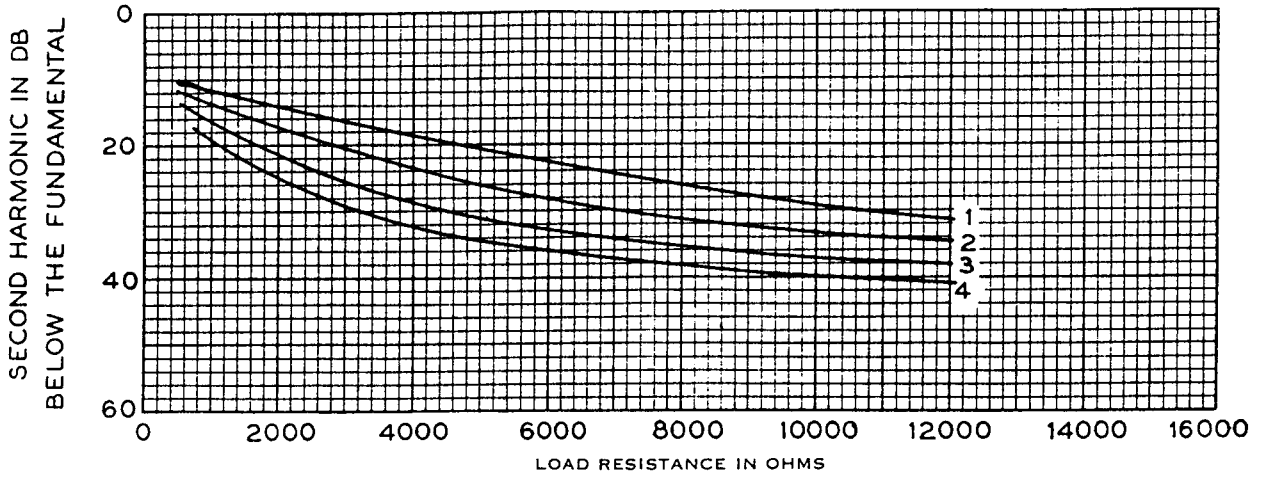

FIG. 9

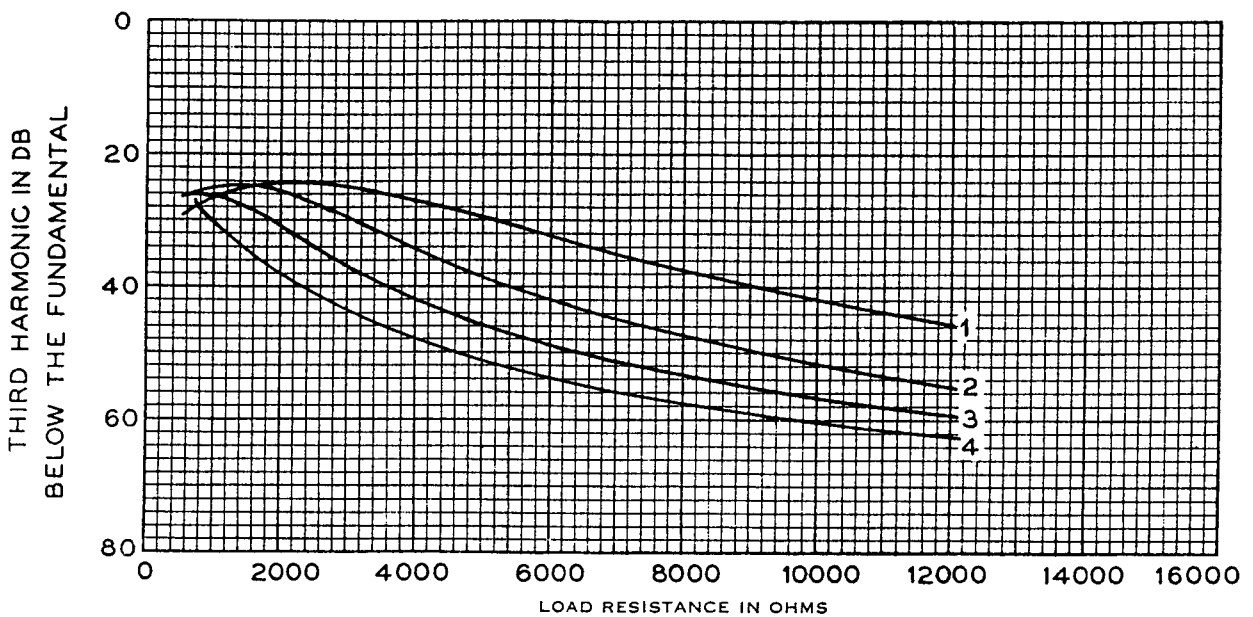

FIG. 10

