

FEATURES

- 4 Matched NPN Transistors (300)
4 Matched PNP Transistors (320)
2 Matched NPNs and PNPs (340)
4 Matched NP6N - 4 Matched PNP (380)
- Monolithic Construction
- Low Noise
 - $0.75 \text{ nV}/\sqrt{\text{Hz}}$ (PNP)
 - $0.8 \text{ nV}/\sqrt{\text{Hz}}$ (NPN)
- High Speed
 - $f_T = 350 \text{ MHz}$ (NPN)
 - $f_T = 325 \text{ MHz}$ (PNP)
- Excellent Matching – 500 μV typical between devices of same gender
- Dielectrically Isolated
- 36V V_{CEO}

APPLICATIONS

- Microphone Preamplifiers
- Current Sources
- Current Mirrors
- Log/Antilog Amplifiers
- Multipliers
- Servos

DESCRIPTION

The THAT300 Series ICs are large-geometry monolithic NPN and/or PNP transistor arrays which combine low noise, high speed and excellent parametric matching between devices of the same gender. The large geometries typically result in 25 Ω base spreading resistance for the PNP devices (30 Ω for the NPNs), producing $0.75 \text{ nV}/\sqrt{\text{Hz}}$ voltage noise ($0.8 \text{ nV}/\sqrt{\text{Hz}}$ for the NPNs). This makes the 300 Series an ideal choice for low-noise amplifier input stages.

Fabricated on a Complementary Bipolar Dielectrically Isolated process, each transistor is electri-

cally isolated from the others by a layer of insulating oxide. The resulting low collector-to-substrate capacitance produces a typical NPN f_T of 350 MHz, 325 MHz for the PNPs. This delivers ac performance similar to discrete 2N3904- and 2N3906-class devices. Dielectric isolation also minimizes crosstalk and provides complete DC isolation.

Substrate biasing is not required for normal operation, though the substrate should be grounded to optimize speed and minimize inter-device crosstalk. The monolithic construction assures excellent parameter matching and tracking over temperature.

Part Number	Configuration	Package
THAT300P	4-Matched NPN Transistors	DIP14
THAT300S		SO14
THAT320P	4- Matched PNP Transistors	DIP14
THAT320S		SO14
THAT340P	2 Matched NPN Transistors and 2 Matched PNP Transistors	DIP14
THAT340S		SO14
THAT380G	4 Matched NPN Transistors and 4 Matched PNP Transistors	Individual Die

Table 1. Ordering Info

SPECIFICATIONS 1

Maximum Ratings ($T_A = 25^\circ\text{C}$)						
Parameter	Symbol	Conditions	Min	Typ	Max	Units
NPN Collector-Emitter Voltage	BV_{CEO}	$I_C = 1 \text{ mAdc}, I_B = 0$	36	40	—	V
NPN Collector-Base Voltage	BV_{CBO}	$I_C = 10 \text{ }\mu\text{Adc}, I_E = 0$	36	40	—	V
NPN Emitter-Base Voltage	BV_{EBO}	$I_E = 100 \text{ }\mu\text{Adc}, I_C = 0$	5	—	—	V
NPN Collector Current	$I_{C \text{ MAX}}$		10	20		mA
NPN Emitter Current	$I_{E \text{ MAX}}$		10	20		mA
PNP Collector-Emitter Voltage	BV_{CEO}	$I_C = 1 \text{ mAdc}, I_B = 0$	-36	-40	—	V
PNP Collector-Base Voltage	BV_{CBO}	$I_C = 10 \text{ }\mu\text{Adc}, I_E = 0$	-36	-40	—	V
PNP Emitter-Base Voltage	BV_{EBO}	$I_E = 100 \text{ }\mu\text{Adc}, I_C = 0$	-5	—	—	V
PNP Collector Current	$I_{C \text{ MAX}}$		-10	-20		mA
PNP Emitter Current	$I_{E \text{ MAX}}$		-10	-20		mA
Collector-Collector Voltage	BV_{CC}		± 100	± 200	—	V
Emitter-Emitter Voltage	BV_{EE}		± 100	± 200	—	V
Operating Temperature Range	T_A		0		70	$^\circ\text{C}$
Maximum Junction Temperature	$T_{J \text{ MAX}}$				150	$^\circ\text{C}$
Storage Temperature	T_{STORE}		-45		125	$^\circ\text{C}$

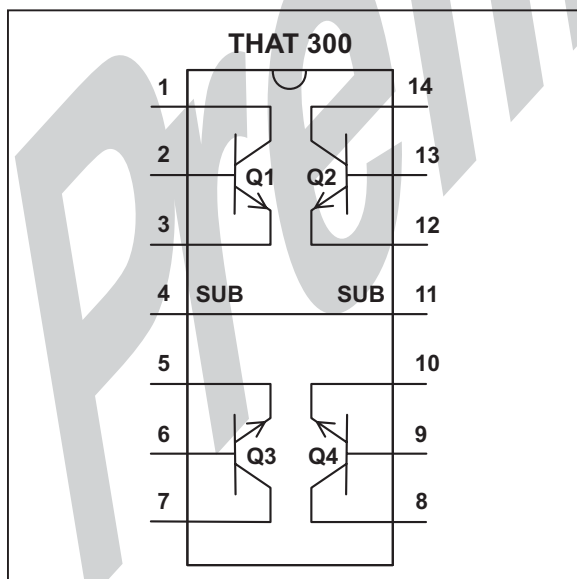

Fig 1. 300 Pinout

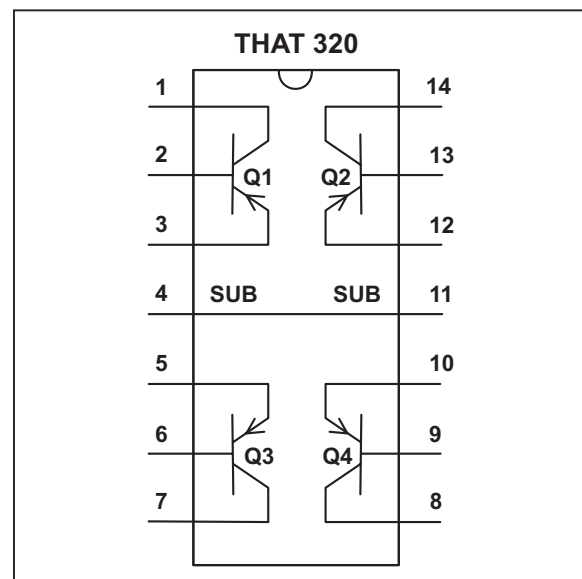

Fig 2. 320 Pinout

SPECIFICATIONS¹ (Cont'd)

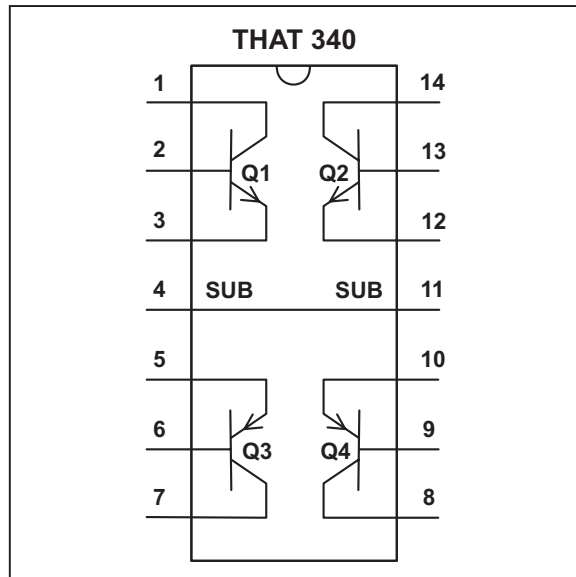

Fig 3. 340 Pinout

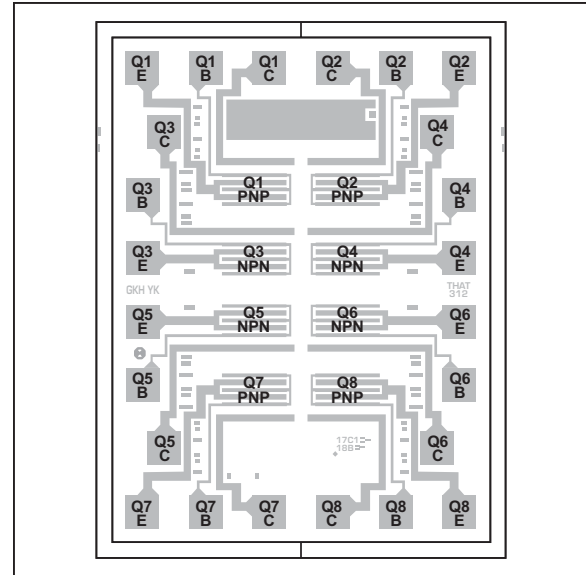

Fig 4. 380 Die layout

NPN Electrical Characteristics²						
Parameter	Symbol	Conditions	Min	Typ	Max	Units
NPN Current Gain	h_{fe}	$V_{CB} = 10\text{ V}$ $I_C = 1\text{ mA}$ $I_C = 10\text{ }\mu\text{A}$	60	100 100	—	—
NPN Current Gain Matching	Δh_{fe}	$V_{CB} = 10\text{ V}, I_C = 1\text{ mA}$	—	5	—	%
NPN Noise Voltage Density	e_N	$V_{CB} = 10\text{ V}, I_C = 1\text{ mA}, 1\text{ kHz}$	—	0.8	—	$nV/\sqrt{\text{Hz}}$
NPN Gain-Bandwidth Product	f_T	$I_C = 1\text{ mA}, V_{CB} = 10\text{ V}$	—	350	—	MHz
NPN ΔV_{BE} (THAT300: $V_{BE1}-V_{BE2}, V_{BE3}-V_{BE4}$) (THAT340: $V_{BE1}-V_{BE2}$)	V_{OS}	$I_C = 1\text{ mA}$ $I_C = 10\text{ }\mu\text{A}$	—	± 0.5 ± 0.5	± 3	mV mV
NPN ΔI_B (THAT300: $I_{B1}-I_{B2}, I_{B3}-I_{B4}$) (THAT340: $I_{B1}-I_{B2}$)	I_{OS}	$I_C = 1\text{ mA}$ $I_C = 10\text{ }\mu\text{A}$	—	± 500 ± 5	± 1500	nA nA
NPN Collector-Base Leakage Current	I_{CBO}	$V_{CB} = 25\text{ V}$	—	25	—	pA
NPN Bulk Resistance	r_{BE}	$V_{CB} = 0\text{ V}, 10\text{ }\mu\text{A} < I_C < 10\text{ mA}$	—	2	—	Ω
NPN Base Spreading Resistance	r_{bb}	$V_{CB} = 10\text{ V}, I_C = 1\text{ mA}$	—	30	—	Ω
NPN Collector Saturation Voltage	$V_{CE(SAT)}$	$I_C = 1\text{ mA}, I_B = 100\text{ }\mu\text{A}$	—	0.05	—	V
NPN Output Capacitance	C_{OB}	$V_{CB} = 10\text{ V}, I_E = 0\text{ mA}, 100\text{ kHz}$	—	3	—	pF
NPN Collector-Collector Capacitance (THAT300: Q1-Q2, Q3-Q4) (THAT340: Q1-Q2)	C_{CC}	$V_{CC} = 0\text{ V}, 100\text{ kHz}$	—	0.7	—	pF

1. All specifications subject to change without notice.
2. Unless otherwise noted, $T_A = 25^\circ\text{C}$.

SPECIFICATIONS¹ (Cont'd)

PNP Electrical Characteristics²						
Parameter	Symbol	Conditions	Min	Typ	Max	Units
PNP Current Gain	h_{fe}	$V_{CB} = 10\text{ V}$	50	75	—	
		$I_C = 1\text{ mA}$		75	—	
		$I_C = 10\text{ }\mu\text{A}$				
PNP Current Gain Matching	Δh_{fe}	$V_{CB} = 10\text{ V}, I_C = 1\text{ mA}$	—	5	—	%
PNP Noise Voltage Density	e_N	$V_{CB} = 10\text{ V}, I_C = 1\text{ mA}, 1\text{ kHz}$	—	0.75	—	$nV/\sqrt{\text{Hz}}$
PNP Gain-Bandwidth Product	f_T	$I_C = 1\text{ mA}, V_{CB} = 10\text{ V}$		325		MHz
PNP ΔV_{BE} (THAT320: $V_{BE1}-V_{BE2}; V_{BE3}-V_{BE4}$) (THAT340: $V_{BE3}-V_{BE4}$)	V_{OS}	$I_C = 1\text{ mA}$	—	± 0.5	± 3	mV
		$I_C = 10\text{ }\mu\text{A}$	—	± 0.5		mV
PNP ΔI_B (THAT320: $I_{B1}-I_{B2}; I_{B3}-I_{B4}$) (THAT340: $I_{B3}-I_{B4}$)	I_{OS}	$I_C = 1\text{ mA}$	—	± 700	± 1800	nA
		$I_C = 10\text{ }\mu\text{A}$	—	± 7		μA
PNP Collector-Base Leakage Current	I_{CBO}	$V_{CB} = 25\text{ V}$	—	-25	—	pA
PNP Bulk Resistance	r_{BE}	$V_{CB} = 0\text{ V}, 10\text{ }\mu\text{A} < I_C < 10\text{ mA}$	—	2	—	Ω
PNP Base Spreading Resistance	r_{bb}	$V_{CB} = 10\text{ V}, I_C = 1\text{ mA}$	—	25	—	Ω
PNP Collector Saturation Voltage	$V_{CE(SAT)}$	$I_C = 1\text{ mA}, I_B = 100\text{ }\mu\text{A}$	—	-0.05		V
PNP Output Capacitance	C_{OB}	$V_{CB} = 10\text{ V}, I_E = 0\text{ mA}, 100\text{ kHz}$		3		pF
PNP Collector-Collector Capacitance (THAT320: Q1-Q2; Q3-Q4) (THAT340: Q3-Q4)	C_{CC}	$V_{CC} = 0\text{ V}, 100\text{ kHz}$		0.6		pF

Information furnished by THAT Corporation is believed to be accurate and reliable. However no responsibility is assumed by THAT Corporation for its use nor for any infringements of patents or other rights of third parties which may result from its use.

LIFE SUPPORT POLICY

THAT Corporation products are not designed for use in life support equipment where malfunction of such products can reasonably be expected to result in personal injury or death. The buyer uses or sells such products for life support application at the buyer's own risk and agrees to hold harmless THAT Corporation from all damages, claims, suits or expense resulting from such use.

CAUTION: THIS IS AN ESD (ELECTROSTATIC DISCHARGE) SENSITIVE DEVICE.

It can be damaged by the currents generated by electrostatic discharge. Static charge and therefore dangerous voltages can accumulate and discharge without detection causing a loss of function or performance to occur.

The transistors in this device are unprotected in order to maximize performance and flexibility. They are more sensitive to ESD damage than many other ICs which include protection devices at their inputs. Note that all of the pins (not just the "inputs") are susceptible.

Use ESD preventative measures when storing and handling this device. Unused devices should be stored in conductive packaging. Packaging should be discharged to the destination socket before the devices are removed. ESD damage can occur to these devices even after they are installed in a board-level assembly. Circuits should include specific and appropriate ESD protection.

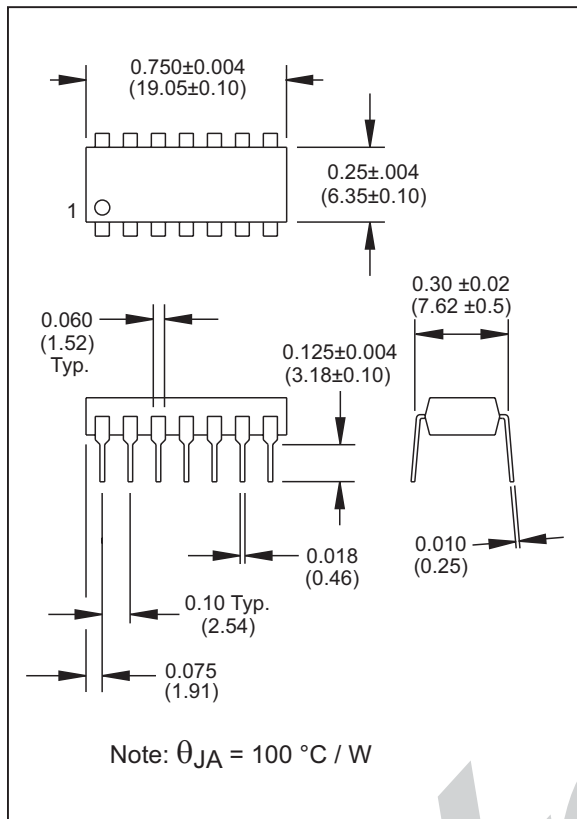

Figure 5. Dual-In-Line Package Outline

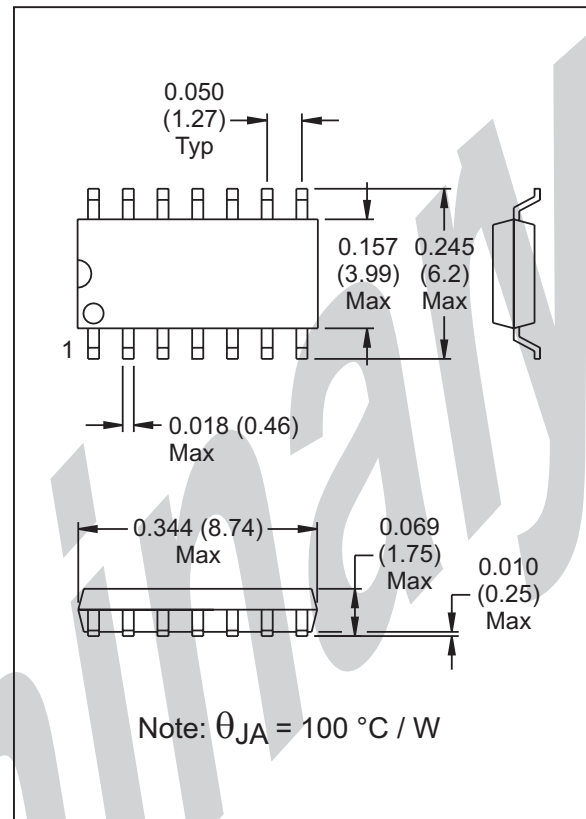

Figure 6. Surface-Mount Package Outline

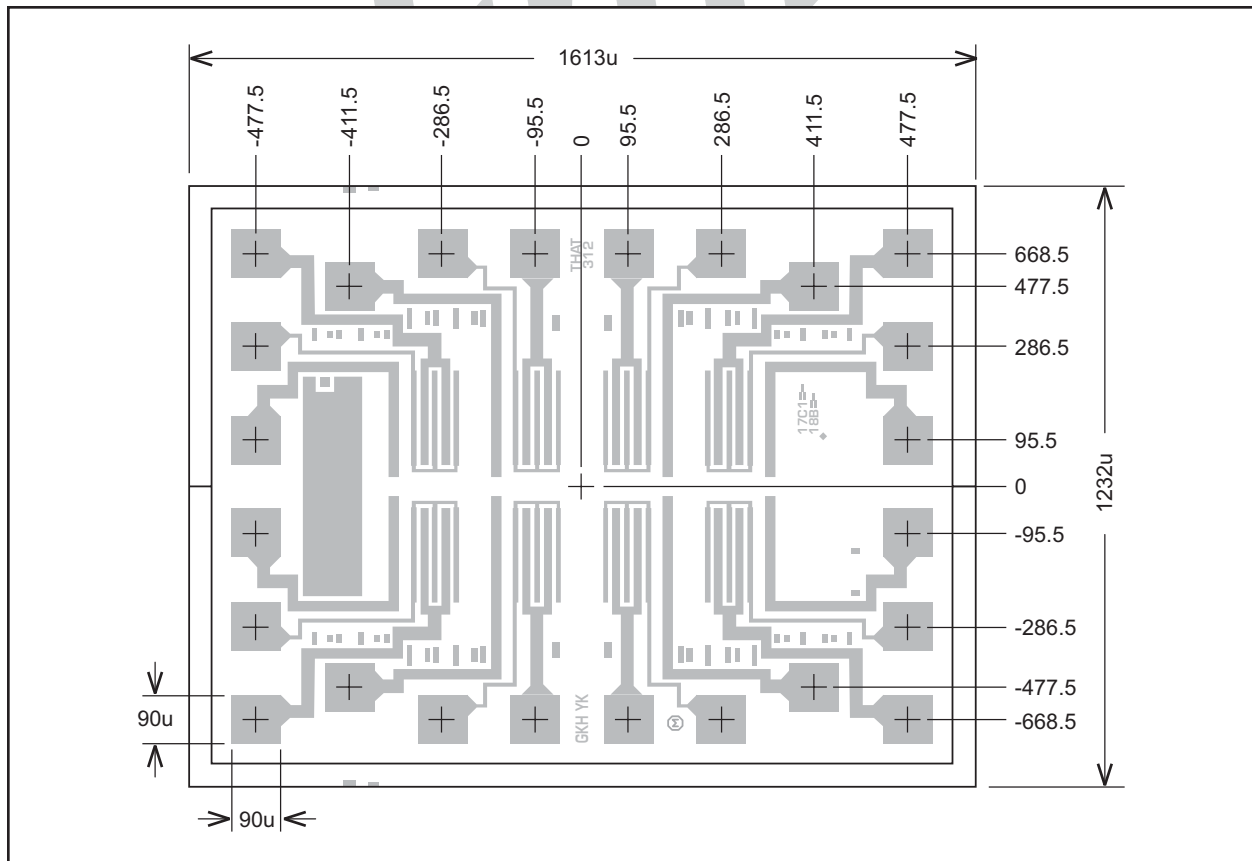

Figure 7. Die dimensions