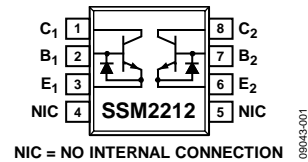

FEATURES**Very low voltage noise: 1 nV/ $\sqrt{\text{Hz}}$ maximum @ 100 Hz****Excellent current gain match: 0.5%****Low offset voltage (V_{OS}): 200 μV maximum****Outstanding offset voltage drift: 0.03 $\mu\text{V}/^\circ\text{C}$** **High gain bandwidth product: 200 MHz****GENERAL DESCRIPTION**

The SSM2212 is a dual, NPN-matched transistor pair that is specifically designed to meet the requirements of ultralow noise audio systems.

With its extremely low input base spreading resistance ($r_{bb'}$ is typically 28 Ω) and high current gain (h_{FE} typically exceeds 600 at $I_C = 1 \text{ mA}$), the SSM2212 can achieve outstanding signal-to-noise ratios. The high current gain results in superior performance compared to systems incorporating commercially available monolithic amplifiers.

Excellent matching of the current gain (Δh_{FE}) to about 0.5% and low V_{OS} of less than 10 μV typical make the SSM2212 ideal for symmetrically balanced designs, which reduce high-order amplifier harmonic distortion.

PIN CONFIGURATION*Figure 1. 8-Lead SOIC_N*

Stability of the matching parameters is guaranteed by protection diodes across the base-emitter junction. These diodes prevent degradation of beta and matching characteristics due to reverse biasing of the base-emitter junction.

The SSM2212 is also an ideal choice for accurate and reliable current biasing and mirroring circuits. Furthermore, because a current mirror's accuracy degrades exponentially with mismatches of V_{BE} between transistor pairs, the low V_{OS} of the SSM2212 does not need offset trimming in most circuit applications.

The SSM2212 performance and characteristics are guaranteed over the extended temperature range of -40°C to $+85^\circ\text{C}$.

Rev. B

Information furnished by Analog Devices is believed to be accurate and reliable. However, no responsibility is assumed by Analog Devices for its use, nor for any infringements of patents or other rights of third parties that may result from its use. Specifications subject to change without notice. No license is granted by implication or otherwise under any patent or patent rights of Analog Devices. Trademarks and registered trademarks are the property of their respective owners.

TABLE OF CONTENTS

Features	1	Thermal Resistance	4
Pin Configuration.....	1	ESD Caution.....	4
General Description	1	Typical Performance Characteristics	5
Revision History	2	Applications Information	8
Specifications.....	3	Fast Logarithmic Amplifier.....	8
Electrical Characteristics	3	Outline Dimensions	9
Absolute Maximum Ratings.....	4	Ordering Guide	9

REVISION HISTORY

7/10—Rev. A to Rev. B

Changes to Figure 1	1
---------------------------	---

6/10—Rev. 0 to Rev. A

Changes to Fast Logarithmic Amplifier Section	8
---	---

6/10—Revision 0: Initial Version

SPECIFICATIONS

ELECTRICAL CHARACTERISTICS

$V_{CB} = 15\text{ V}$, $I_O = 10\text{ }\mu\text{A}$, $T_A = 25^\circ\text{C}$, unless otherwise specified.

Table 1.

Parameter	Symbol	Text Conditions/Comments	Min	Typ	Max	Unit
DC AND AC CHARACTERISTICS						
Current Gain ¹	h_{FE}	$I_C = 1\text{ mA}$ $-40^\circ\text{C} \leq T_A \leq +85^\circ\text{C}$	300	605		
		$I_C = 10\text{ }\mu\text{A}$ $-40^\circ\text{C} \leq T_A \leq +85^\circ\text{C}$	300			
			200	550		
			200			
Current Gain Match ²	Δh_{FE}	$10\text{ }\mu\text{A} \leq I_C \leq 1\text{ mA}$		0.5	5	%
Noise Voltage Density ³	e_N	$I_C = 1\text{ mA}$, $V_{CB} = 0\text{ V}$ $f_O = 10\text{ Hz}$		1.6	2	nV/ $\sqrt{\text{Hz}}$
		$f_O = 100\text{ Hz}$		0.9	1	nV/ $\sqrt{\text{Hz}}$
		$f_O = 1\text{ kHz}$		0.85	1	nV/ $\sqrt{\text{Hz}}$
		$f_O = 10\text{ kHz}$		0.85	1	nV/ $\sqrt{\text{Hz}}$
Low Frequency Noise (0.1 Hz to 10 Hz)	$e_N\text{ p-p}$	$I_C = 1\text{ mA}$		0.4		$\mu\text{V p-p}$
Offset Voltage	V_{OS}	$V_{CB} = 0\text{ V}$, $I_C = 1\text{ mA}$ $-40^\circ\text{C} \leq T_A \leq +85^\circ\text{C}$		10	200	μV
					220	μV
Offset Voltage Change vs. V_{CB}	$\Delta V_{OS}/\Delta V_{CB}$	$0\text{ V} \leq V_{CB} \leq V_{MAX}^4$, $1\text{ }\mu\text{A} \leq I_C \leq 1\text{ mA}^5$		10	50	μV
Offset Voltage Change vs. I_C	$\Delta V_{OS}/\Delta I_C$	$1\text{ }\mu\text{A} \leq I_C \leq 1\text{ mA}^5$, $V_{CB} = 0\text{ V}$		5	70	μV
Offset Voltage Drift	$\Delta V_{OS}/\Delta T$	$-40^\circ\text{C} \leq T_A \leq +85^\circ\text{C}$ $-40^\circ\text{C} \leq T_A \leq +85^\circ\text{C}$, V_{OS} trimmed to 0 V		0.08	1	$\mu\text{V}/^\circ\text{C}$
				0.03	0.3	$\mu\text{V}/^\circ\text{C}$
Breakdown Voltage	BV_{CEO}		40			V
Gain Bandwidth Product	f_T	$I_C = 100\text{ mA}$, $V_{CE} = 10\text{ V}$		200		MHz
Collector-to-Base Leakage Current	I_{CBO}	$V_{CB} = V_{MAX}$ $-40^\circ\text{C} \leq T_A \leq +85^\circ\text{C}$		25	500	pA
				3		nA
Collector-to-Collector Leakage Current	I_{CC}	$V_{CC} = V_{MAX}^{6,7}$ $-40^\circ\text{C} \leq T_A \leq +85^\circ\text{C}$		35	500	pA
				4		nA
Collector-to-Emitter Leakage Current	I_{CES}	$V_{CE} = V_{MAX}$, $V_{BE} = 0\text{ V}^{6,7}$ $-40^\circ\text{C} \leq T_A \leq +85^\circ\text{C}$		35	500	pA
				4		nA
Input Bias Current	I_B	$I_C = 10\text{ }\mu\text{A}$ $-40^\circ\text{C} \leq T_A \leq +85^\circ\text{C}$			50	nA
					50	nA
Input Offset Current	I_{OS}	$I_C = 10\text{ }\mu\text{A}$ $-40^\circ\text{C} \leq T_A \leq +85^\circ\text{C}$			6.2	nA
					13	nA
Input Offset Current Drift	$\Delta I_{OS}/\Delta T$	$I_C = 10\text{ }\mu\text{A}^6$, $-40^\circ\text{C} \leq T_A \leq +85^\circ\text{C}$		40	150	pA/ $^\circ\text{C}$
Collector Saturation Voltage	$V_{CE(SAT)}$	$I_C = 1\text{ mA}$, $I_B = 100\text{ }\mu\text{A}$		0.05	0.2	V
Output Capacitance	C_{OB}	$V_{CB} = 15\text{ V}$, $I_E = 0\text{ }\mu\text{A}$		23		pF
Bulk Resistance	R_{BE}	$10\text{ }\mu\text{A} \leq I_C \leq 10\text{ mA}^6$		0.3	1.6	Ω
Collector-to-Collector Capacitance	C_{CC}	$V_{CC} = 0\text{ V}$		35		pF

¹ Current gain is guaranteed with collector-to-base voltage (V_{CB}) swept from 0 V to V_{MAX} at the indicated collector currents.

² Current gain match (Δh_{FE}) is defined as follows: $\Delta h_{FE} = (100(\Delta I_B)/(h_{FE\text{ min}})/I_C)$.

³ Noise voltage density is guaranteed, but not 100% tested.

⁴ This is the maximum change in V_{OS} as V_{CB} is swept from 0 V to 40 V.

⁵ Measured at $I_C = 10\text{ }\mu\text{A}$ and guaranteed by design over the specified range of I_C .

⁶ Guaranteed by design.

⁷ I_{CC} and I_{CES} are verified by measurement of I_{CBO} .

ABSOLUTE MAXIMUM RATINGS

Table 2.

Parameter	Rating
Breakdown Voltage of Collector-to-Base Voltage (BV_{CBO})	40 V
Breakdown Voltage of Collector-to-Emitter Voltage (BV_{CEO})	40 V
Breakdown Voltage of Collector-to-Collector Voltage (BV_{CC})	40 V
Breakdown Voltage of Emitter-to-Emitter Voltage (BV_{EE})	40 V
Collector Current (I_C)	20 mA
Emitter Current (I_E)	20 mA
Storage Temperature Range	-65°C to +150°C
Operating Temperature Range	-40°C to +85°C
Junction Temperature Range	-65°C to +150°C
Lead Temperature (Soldering, 60 sec)	300°C

Stresses above those listed under Absolute Maximum Ratings may cause permanent damage to the device. This is a stress rating only; functional operation of the device at these or any other conditions above those indicated in the operational section of this specification is not implied. Exposure to absolute maximum rating conditions for extended periods may affect device reliability.

THERMAL RESISTANCE

θ_{JA} is specified for the worst-case conditions, that is, a device soldered in a circuit board for surface-mount packages.

Table 3. Thermal Resistance

Package Type	θ_{JA}	θ_{JC}	Unit
8-Lead SOIC (R-8)	120	45	°C/W

ESD CAUTION



ESD (electrostatic discharge) sensitive device. Charged devices and circuit boards can discharge without detection. Although this product features patented or proprietary protection circuitry, damage may occur on devices subjected to high energy ESD. Therefore, proper ESD precautions should be taken to avoid performance degradation or loss of functionality.

TYPICAL PERFORMANCE CHARACTERISTICS

$T_A = 25^\circ\text{C}$, $V_{CE} = 5\text{ V}$, unless otherwise specified.

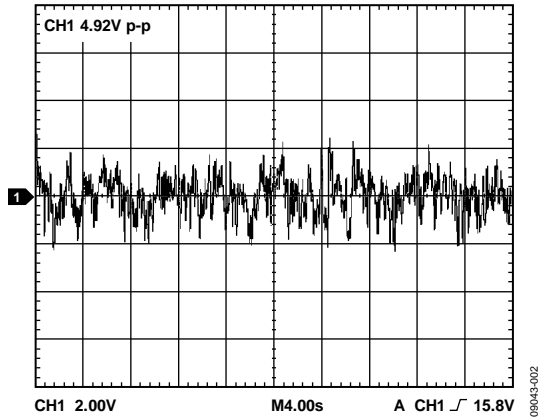

Figure 2. Low Frequency Noise (0.1 Hz to 10 Hz), $I_C = 1\text{ mA}$, Gain = 10,000,000

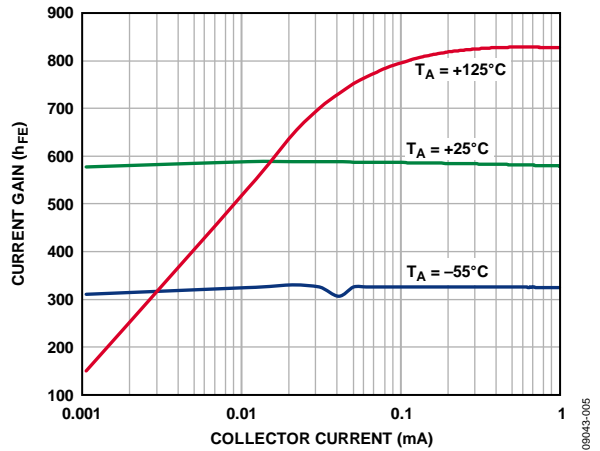

Figure 5. Current Gain vs. Collector Current ($V_{CB} = 0\text{ V}$)

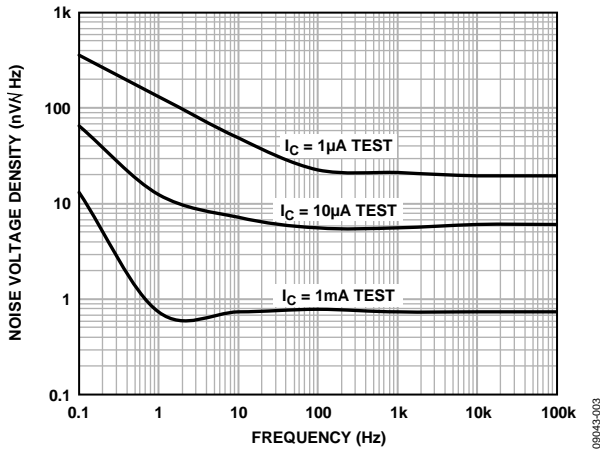

Figure 3. Noise Voltage Density vs. Frequency

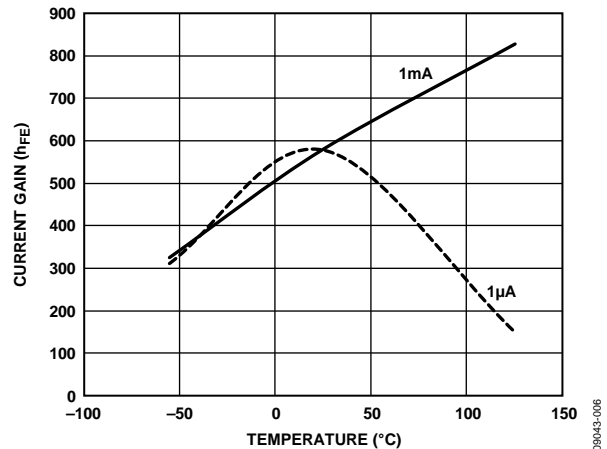

Figure 6. Current Gain vs. Temperature (Excludes I_{CB0})

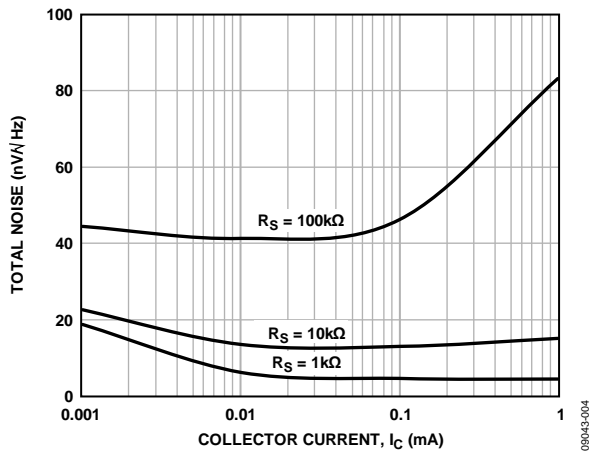

Figure 4. Total Noise vs. Collector Current, $f = 1\text{ kHz}$

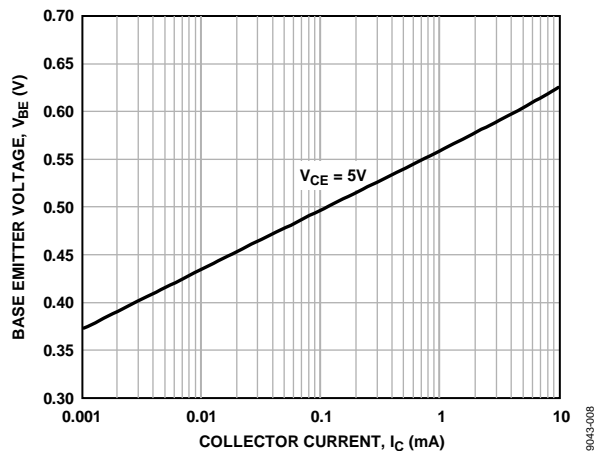

Figure 7. Base Emitter Voltage vs. Collector Current

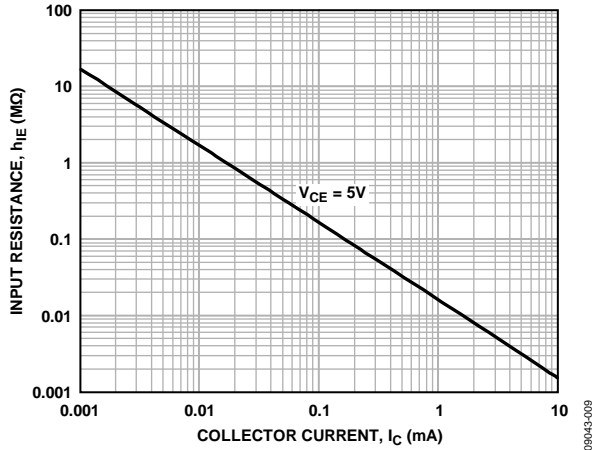

Figure 8. Small Signal Input Resistance vs. Collector Current

09043-009

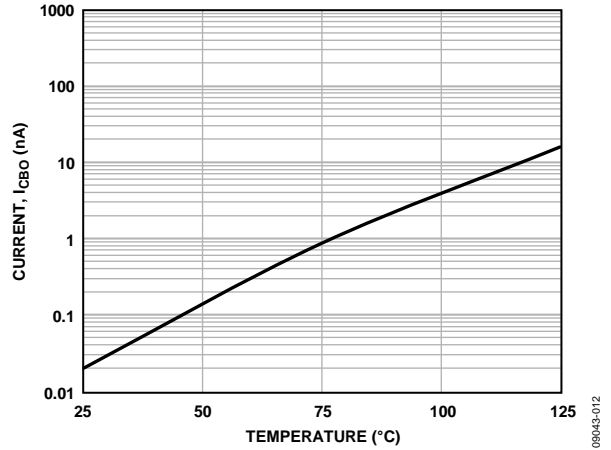

Figure 11. Collector-to-Base Leakage Current vs. Temperature

09043-012

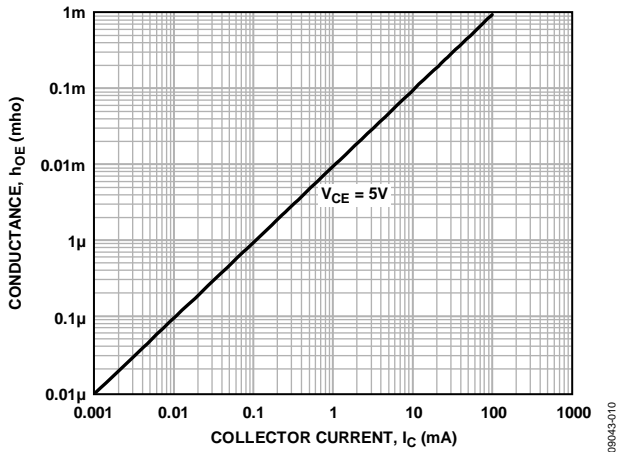

Figure 9. Small Signal Output Conductance vs. Collector Current

09043-010

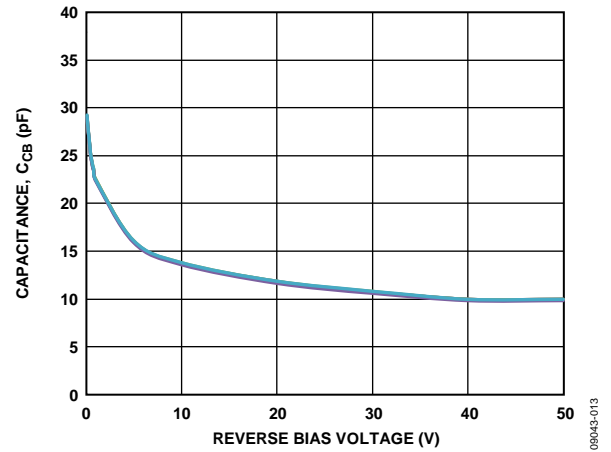

Figure 12. Collector-to-Base Capacitance vs. Reverse Bias Voltage

09043-013

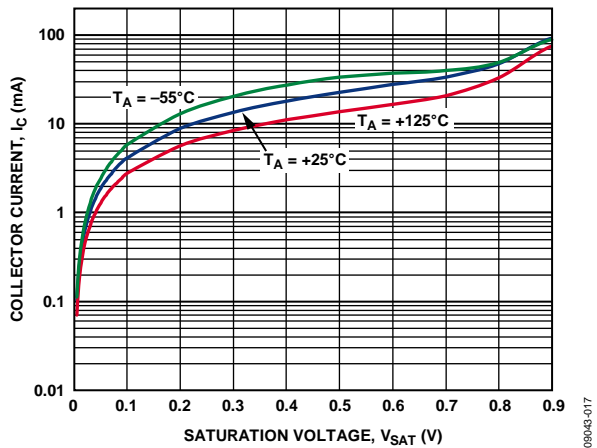

Figure 10. Collector Current vs. Saturation Voltage

09043-017

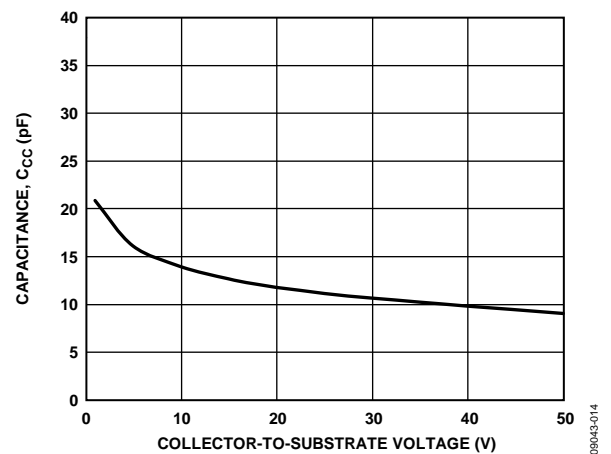

Figure 13. Collector-to-Collector Capacitance vs. Collector-to-Substrate Voltage

09043-014

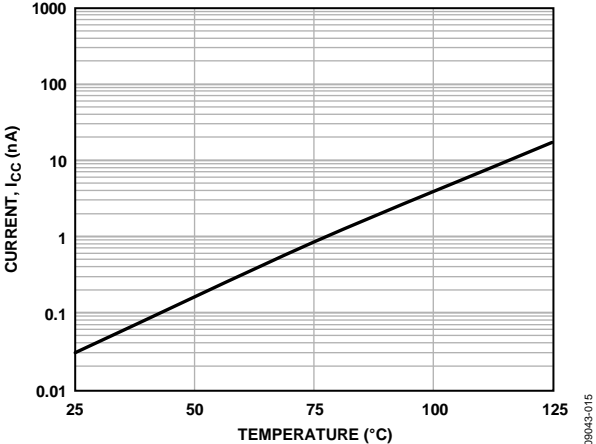

Figure 14. Collector-to-Collector Leakage Current vs. Temperature

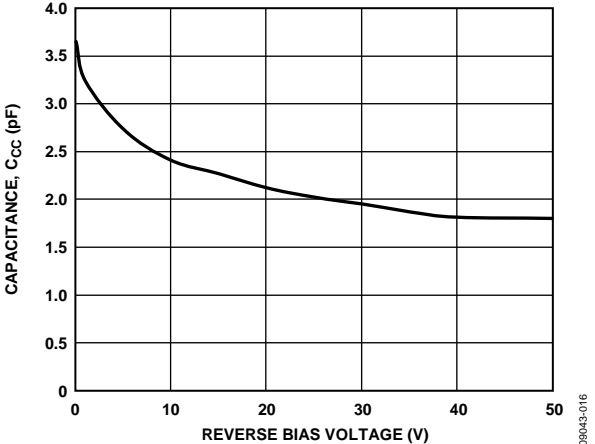

Figure 15. Collector-to-Collector Capacitance vs. Reverse Bias Voltage

APPLICATIONS INFORMATION

FAST LOGARITHMIC AMPLIFIER

The circuit of Figure 16 is a modification of a standard logarithmic amplifier configuration. Running the SSM2212 at 2.5 mA per side (full-scale) allows for a fast response with a wide dynamic range. The circuit has a 7 decade current range and a 5 decade voltage range, and it is capable of 2.5 μ s settling time to 1% with a 1 V to 10 V step. The output follows the equation:

$$V_O = -\frac{R_3 + R_2}{R_2} \frac{kT}{q} \ln \frac{V_{REF}}{V_{IN}}$$

To compensate for the temperature dependence of the kT/q term, a resistor with a positive 0.35%/°C temperature coefficient is chosen for R_2 . The output is inverted with respect to the input and is nominally -1 V/decade using the component values indicated.

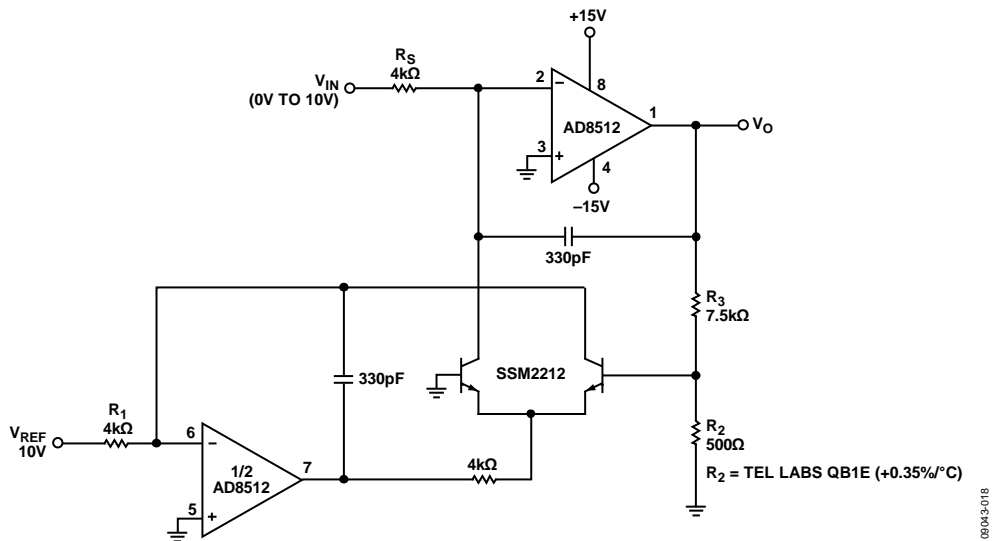
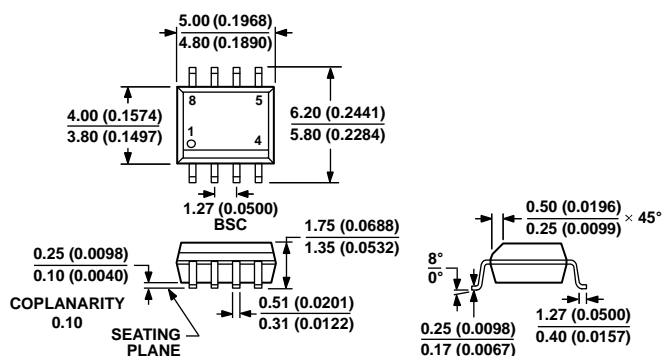

Figure 16. Fast Logarithmic Amplifier

OUTLINE DIMENSIONS



COMPLIANT TO JEDEC STANDARDS MS-012-AA
 CONTROLLING DIMENSIONS ARE IN MILLIMETERS; INCH DIMENSIONS
 (IN PARENTHESES) ARE ROUNDED-OFF MILLIMETER EQUIVALENTS FOR
 REFERENCE ONLY AND ARE NOT APPROPRIATE FOR USE IN DESIGN.

01240P-A

Figure 17. 8-Lead Standard Small Outline Package [SOIC_N]
 Narrow Body
 (R-8)

Dimensions shown in millimeters and (inches)

ORDERING GUIDE

Model ¹	Temperature Range	Package Description	Package Option
SSM2212RZ	-40°C to +85°C	8-Lead Standard Small Outline Package [SOIC_N]	R-8
SSM2212RZ-R7	-40°C to +85°C	8-Lead Standard Small Outline Package [SOIC_N]	R-8
SSM2212RZ-RL	-40°C to +85°C	8-Lead Standard Small Outline Package [SOIC_N]	R-8

¹ Z = RoHS Compliant Part.

NOTES

NOTES

SSM2212

NOTES