

**Normally-On Trench Silicon Carbide Power JFET**

Product Summary		
$BV_{DS}$	1200	V
$R_{DS(ON)max}$	0.340	$\Omega$
$E_{TS,typ}$	TBD	$\mu J$

**Features:**

- Positive Temperature Coefficient for Ease of Paralleling
- Extremely Fast Switching with No "Tail" Current at 150 °C
- $R_{DS(on)}$  typical of 0.270  $\Omega$
- Voltage Controlled
- Low Gate Charge
- Low Intrinsic Capacitance

**Applications:**

- Solar Inverter
- SMPS
- Power Factor Correction
- UPS

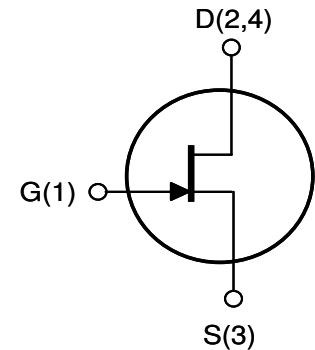
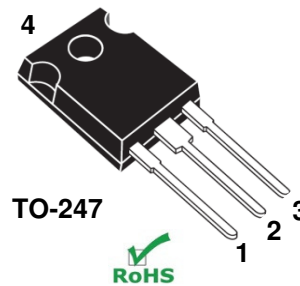

Internal Schematic

**MAXIMUM RATINGS**

Parameter	Symbol	Conditions	Value	Unit
Continuous Drain Current	$I_{D, TC=25}$	$T_C = 25\text{ }^\circ\text{C}$	8	A
	$I_{D, TC=100}$	$T_C = 100\text{ }^\circ\text{C}$	5	
Pulsed Drain Current <sup>(1)</sup>	$I_{DM}$	$T_j = 25\text{ }^\circ\text{C}$	17	A
Short Circuit Withstand Time	$t_{SC}$	$V_{DD} < 800\text{ V}, T_j < 125\text{ }^\circ\text{C}$	50	$\mu\text{s}$
Power Dissipation	$P_D$	$T_C = 25\text{ }^\circ\text{C}$	48	W
Gate-Source Voltage	$V_{GS}$	AC <sup>(2)</sup>	-15 to +15	V
Operating and Storage Temperature	$T_j, T_{stg}$		-55 to +150	$^\circ\text{C}$
Lead Temperature for Soldering	$T_{sold}$	1/8" from case < 10 s	260	$^\circ\text{C}$

<sup>(1)</sup> Pulse width limited by maximum junction temperature

<sup>(2)</sup>  $R_{g(EXT)} = 1\text{ ohm}, t_p \leq 200\text{ns}$ , see Figure 5 for static conditions

**THERMAL CHARACTERISTICS**

Parameter	Symbol	Value		Unit
		Typ	Max	
Thermal Resistance, junction-to-case	$R_{th,JC}$	-	2.6	$^\circ\text{C} / \text{W}$
Thermal Resistance, junction-to-ambient	$R_{th,JA}$	-	50	

**ELECTRICAL CHARACTERISTICS**

Parameter	Symbol	Conditions	Value			Unit
			Min	Typ	Max	

**Off Characteristics**

Drain-Source Blocking Voltage	$BV_{DS}$	$V_{GS} = -15\text{ V}, I_D = 200\ \mu\text{A}$	1200	-	-	V
Total Drain Leakage Current	$I_{DSS}$	$V_{DS} = 1200\text{ V}, V_{GS} = -15\text{ V}, T_j = 25^\circ\text{C}$	-	TBD	-	$\mu\text{A}$
		$V_{DS} = 1200\text{ V}, V_{GS} = -15\text{ V}, T_j = 150^\circ\text{C}$	-	TBD	-	
Total Gate Reverse Leakage	$I_{GSS}$	$V_{GS} = -15\text{ V}, V_{DS} = 0\text{ V}$	-	-50	-100	$\mu\text{A}$
		$V_{GS} = -15\text{ V}, V_{DS} = 1200\text{ V}$	-	TBD	-	

**On Characteristics**

Drain-Source On-resistance	$R_{DS(on)}$	$I_D = 5\text{ A}, V_{GS} = 2\text{ V}, T_j = 25^\circ\text{C}$	-	0.27	0.34	$\Omega$
		$I_D = 5\text{ A}, V_{GS} = 2\text{ V}, T_j = 100^\circ\text{C}$	-	0.60	-	
Gate Threshold Voltage	$V_{GS(th)}$	$V_{DS} = 1\text{ V}, I_D = 9\text{ mA}$	-	-5	-	V
Gate Forward Current	$I_{G(FWD)}$	$V_{GS} = +2\text{ V}$	-	10	-	$\mu\text{A}$
Gate Resistance	$R_G$	$f = 1\text{ MHz}, \text{ drain-source shorted}$	-	TBD	-	$\Omega$
	$R_{G(on)}$	$V_{GS} > 2.7\text{ V}; \text{ See Figure 5}$	-	TBD	-	$\Omega$

**Dynamic Characteristics**

Input Capacitance	$C_{iss}$	$V_{DD} = 100\text{ V}, V_{GS} = -15\text{ V}, f = 100\text{ kHz}$	-	TBD	-	$\text{pF}$
Output Capacitance	$C_{oss}$		-	TBD	-	
Reverse Transfer Capacitance	$C_{rss}$		-	TBD	-	
Effective Output Capacitance, energy related	$C_{o(er)}$	$V_{DS} = 0\text{ V to } 600\text{ V}, V_{GS} = -15\text{ V}$	-	TBD	-	

**Switching Characteristics**

Turn-on Delay	$t_{on}$	$V_{DS} = 600\text{ V}, I_D = 5\text{ A}, \text{ Inductive Load}, T_j = 25^\circ\text{C}$ Gate Driver = +15V, -15V	-	TBD	-	ns
Rise Time	$t_r$		-	TBD	-	
Turn-off Delay	$t_{off}$		-	TBD	-	
Fall Time	$t_f$		-	TBD	-	
Turn-on Energy	$E_{on}$		-	TBD	-	
Turn-off Energy	$E_{off}$	-	TBD	-		
Total Switching Energy	$E_{ts}$	-	TBD	-		
Turn-on Delay	$t_{on}$	$V_{DS} = 600\text{ V}, I_D = 5\text{ A}, \text{ Inductive Load}, T_j = 150^\circ\text{C}$ Gate Driver = +15V, -15V	-	TBD	-	ns
Rise Time	$t_r$		-	TBD	-	
Turn-off Delay	$t_{off}$		-	TBD	-	
Fall Time	$t_f$		-	TBD	-	
Turn-on Energy	$E_{on}$		-	TBD	-	
Turn-off Energy	$E_{off}$	-	TBD	-		
Total Switching Energy	$E_{ts}$	-	TBD	-		
Total Gate Charge	$Q_g$	$V_{DS} = 600\text{ V}, I_D = 2.5\text{ A}, V_{GS} = +2.5\text{ V}$	-	TBD	-	nC
Gate-Source Charge	$Q_{gs}$		-	TBD	-	
Gate-Drain Charge	$Q_{gd}$		-	TBD	-	

**Figure 1. Typical Output Characteristics**

$I_D = f(V_{DS}); T_J = 25\text{ }^\circ\text{C}; \text{parameter: } V_{GS}$

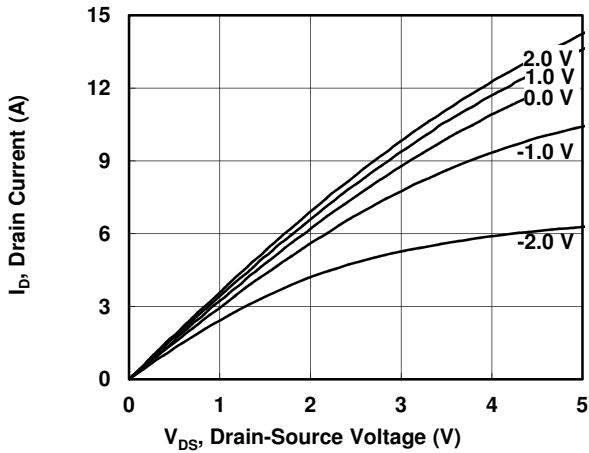

**Figure 2. Typical Output Characteristics**

$I_D = f(V_{DS}); T_J = 100\text{ }^\circ\text{C}; \text{parameter: } V_{GS}$

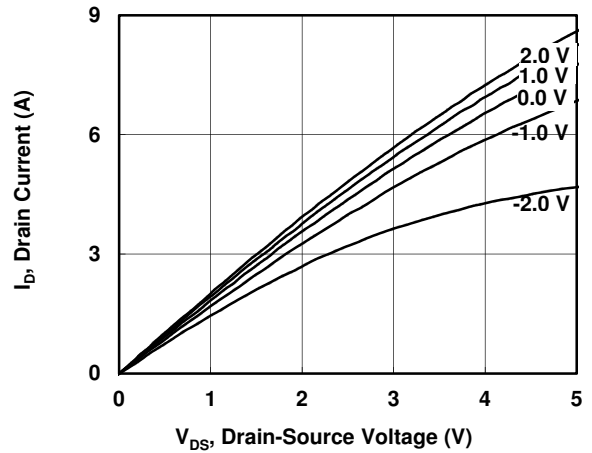

**Figure 3. Typical Output Characteristics**

$I_D = f(V_{DS}); T_J = 150\text{ }^\circ\text{C}; \text{parameter: } V_{GS}$

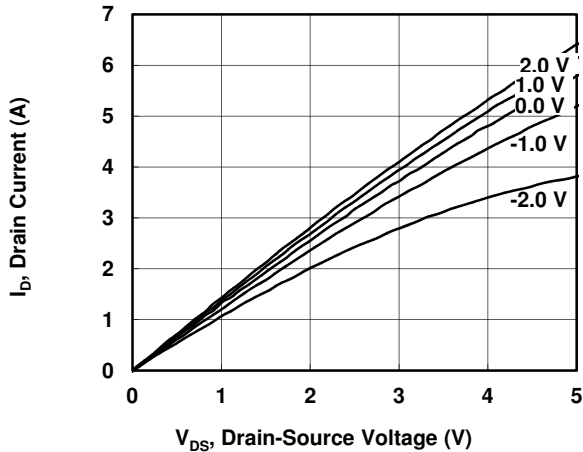

**Figure 4. Typical Transfer Characteristics**

$I_D = f(V_{GS}); V_{DS} = 5\text{ V}; T_J = 25\text{ }^\circ\text{C}$

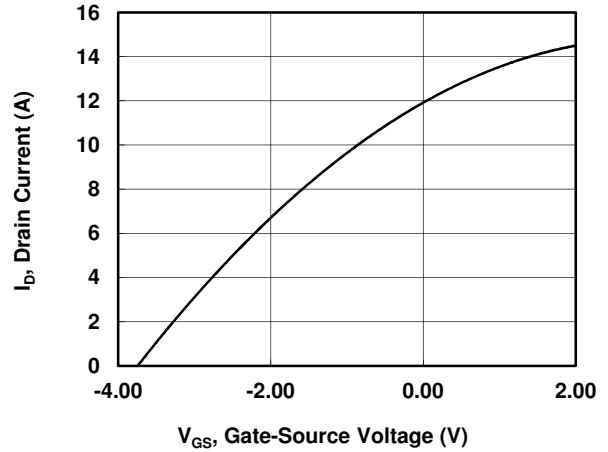

**Figure 5. Gate Current**

$I_G = f(V_{GS}); \text{parameter: } T_J$

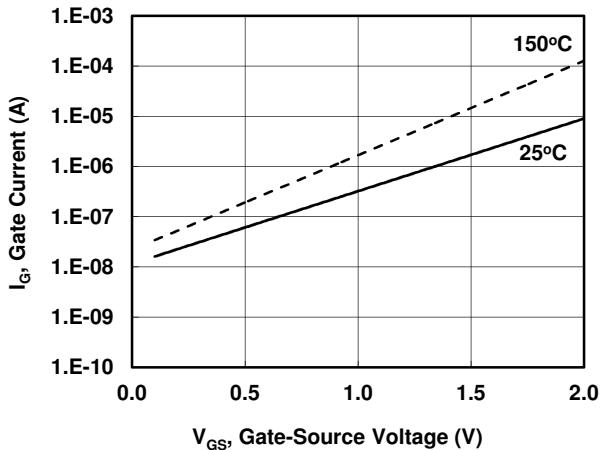

**Figure 6. Drain-Source On-resistance**

$R_{DS(on)} = f(I_D); V_{GS} = 2.0\text{ V}; \text{parameter: } T_J$

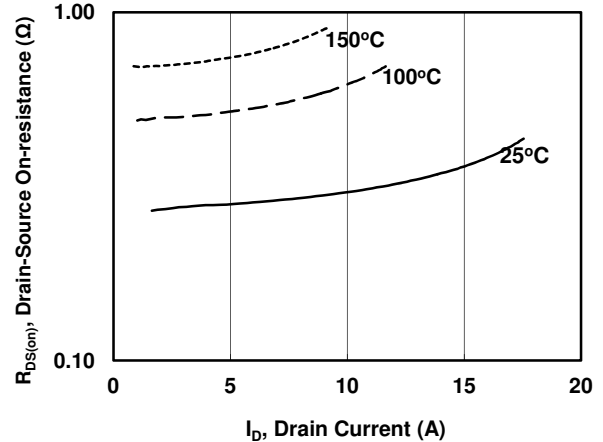

**Figure 7. Drain-Source On-resistance**

$R_{DS(ON)} = f(T_j); I_D = 5 \text{ A}; \text{parameter: } V_{GS}$

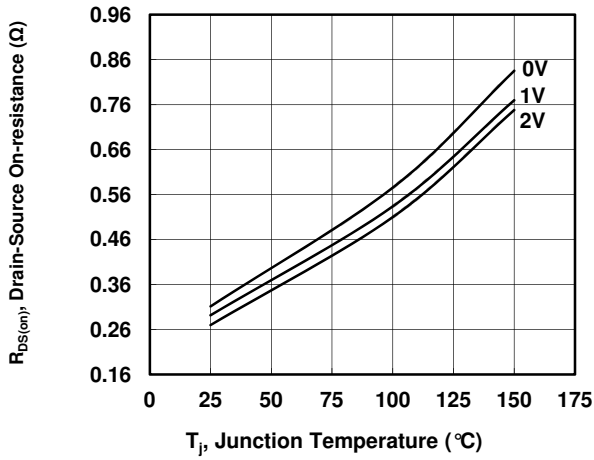

**Figure 8. Drain-Source On-resistance**

$R_{DS(on)} = f(V_{GS}); I_D = 5 \text{ A}; T_j = 25^\circ\text{C}$

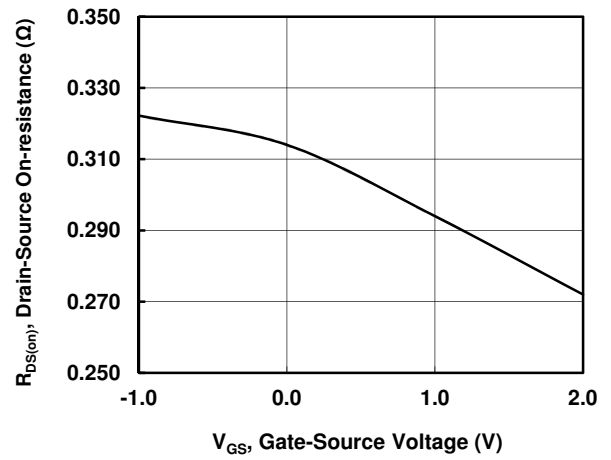

**Figure 10. Drain-Source Leakage**

$I_{DSS} = f(V_{DS}); V_{GS} = -15\text{V}; \text{parameter: } T_j$

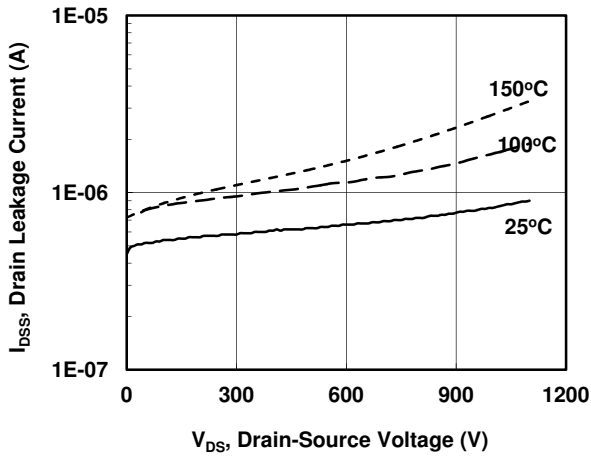

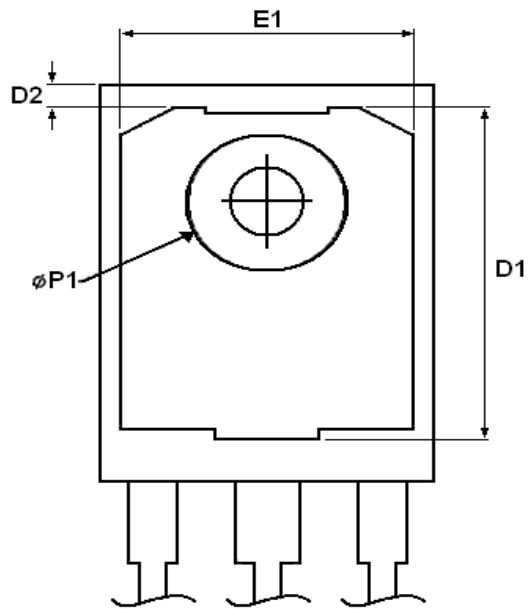
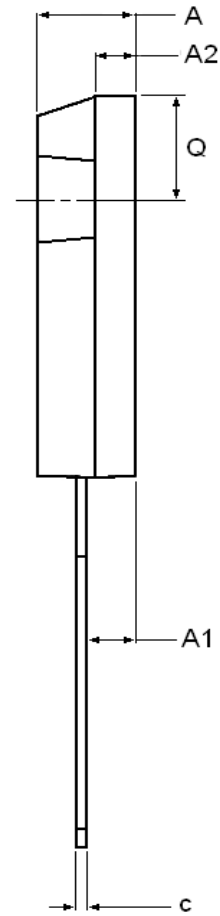
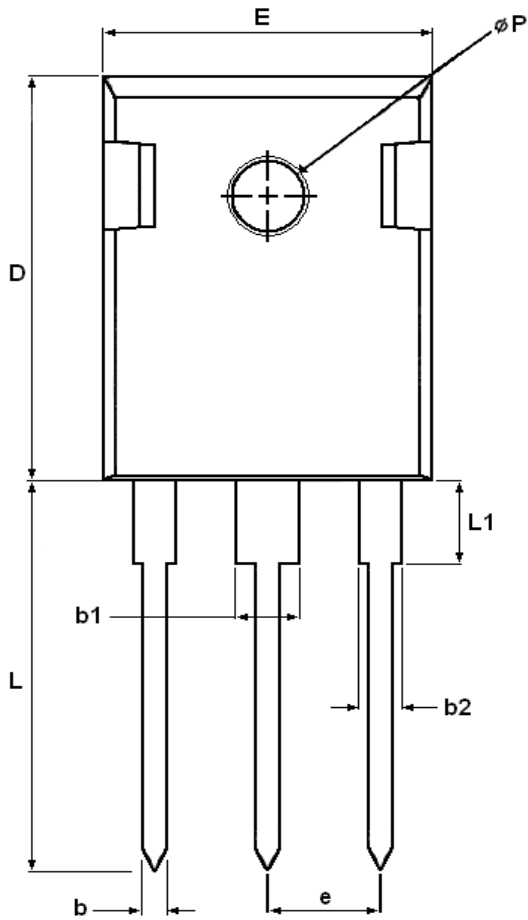

DIM	MILLIMETERS		INCHES	
	MIN	MAX	MIN	MAX
A	4.903	5.157	0.193	0.203
A1	2.273	2.527	0.090	0.100
A2	1.853	2.108	0.073	0.083
b	1.073	1.327	0.042	0.052
b1	2.873	3.381	0.113	0.133
b2	1.903	2.386	0.075	0.094
c	0.600	0.752	0.024	0.029
D	20.823	21.077	0.820	0.830
D1	17.393	17.647	0.685	0.695
D2	1.063	1.317	0.042	0.052
e	5.450		0.215	
E	15.773	16.027	0.621	0.631
E1	13.893	14.147	0.547	0.557
L	20.053	20.307	0.789	0.799
L1	4.168	4.472	0.165	0.175
Q	6.043	6.297	0.238	0.248
ØP	3.560	3.660	0.140	0.144
ØP1	7.063	7.317	0.278	0.288

Published by  
SemiSouth Laboratories, Inc.  
201 Research Boulevard  
Starkville, MS 39759 USA  
© SemiSouth Laboratories, Inc. 2012

Information in this document supersedes and replaces all information previously supplied.

Information in this document is provided solely in connection with SemiSouth products. SemiSouth Laboratories, Inc. reserves the right to make changes, corrections, modifications or improvements, to this document without notice.

No license, express or implied to any intellectual property rights is granted under this document.

Unless expressly approved in writing by an authorized representative of SemiSouth, SemiSouth products are not designed, authorized or warranted for use in military, aircraft, space, life saving, or life sustaining applications, nor in products or systems where failure or malfunction may result in personal injury, death, or property or environmental damage.