

**Normally-OFF Trench Silicon Carbide Power JFET**

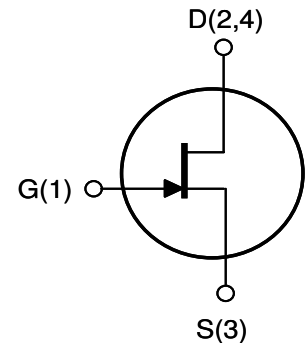
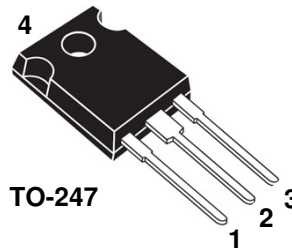
**Features:**

- Compatible with Standard Gate Driver ICs
- Positive Temperature Coefficient for Ease of Paralleling
- Extremely Fast Switching with No "Tail" Current at 150 °C
- 150 °C Maximum Operating Temperature
- $R_{DS(on)max}$  of 0.100  $\Omega$
- Voltage Controlled
- Low Gate Charge
- Low Intrinsic Capacitance

**Applications:**

High Performance Audio

Product Summary		
$BV_{DS}$	1200	V
$R_{DS(ON)max}$	0.100	$\Omega$
$E_{TS,typ}$	170	$\mu J$



Internal Schematic

**MAXIMUM RATINGS**

Parameter	Symbol	Conditions	Value	Unit
Continuous Drain Current	$I_D, T_j=100$	$T_j = 100\text{ }^\circ\text{C}$	17	A
	$I_D, T_j=150$	$T_j = 150\text{ }^\circ\text{C}$	11	
Pulsed Drain Current <sup>(1)</sup>	$I_{DM}$	$T_C = 25\text{ }^\circ\text{C}$	30	A
Short Circuit Withstand Time	$t_{SC}$	$V_{DD} < 800\text{ V}, T_C < 125\text{ }^\circ\text{C}$	50	$\mu\text{s}$
Power Dissipation	$P_D$	$T_C = 25\text{ }^\circ\text{C}$	114	W
Gate-Source Voltage	$V_{GS}$	AC <sup>(2)</sup>	-10 to +15	V
Operating and Storage Temperature	$T_j, T_{j, stg}$		-55 to +150	$^\circ\text{C}$
Lead Temperature for Soldering	$T_{sold}$	1/8" from case < 10 s	260	$^\circ\text{C}$

<sup>(1)</sup> Limited by pulse width

<sup>(2)</sup>  $R_{gEXT} = 1\text{ ohm}, t_p \leq 200\text{ns}$ , see Figure 5 for static conditions

**THERMAL CHARACTERISTICS**

Parameter	Symbol	Value		Unit
		Typ	Max	
Thermal Resistance, junction-to-case	$R_{th,JC}$	-	1.1	$^\circ\text{C} / \text{W}$
Thermal Resistance, junction-to-ambient	$R_{th,JA}$	-	50	

**ELECTRICAL CHARACTERISTICS**

Parameter	Symbol	Conditions	Value			Unit
			Min	Typ	Max	

**Off Characteristics**

Drain-Source Blocking Voltage	$BV_{DS}$	$V_{GS} = 0\text{ V}, I_D = 600\ \mu\text{A}$	1200	-	-	V
Total Drain Leakage Current	$I_{DSS}$	$V_{DS} = 1200\text{ V}, V_{GS} = 0\text{ V}, T_j = 25^\circ\text{C}$	-	100	600	$\mu\text{A}$
		$V_{DS} = 1200\text{ V}, V_{GS} = 0\text{ V}, T_j = 150^\circ\text{C}$	-	300	-	
		$V_{DS} = 1200\text{ V}, V_{GS} \leq -10\text{ V}, T_j = 25^\circ\text{C}$	-	1	-	
		$V_{DS} = 1200\text{ V}, V_{GS} \leq -10\text{ V}, T_j = 150^\circ\text{C}$	-	10	-	
Total Gate Reverse Leakage	$I_{GSS}$	$V_{GS} = -10\text{ V}, V_{DS} = 0\text{ V}$	-	-0.1	-0.3	mA
		$V_{GS} = -10\text{ V}, V_{DS} = 1200\text{ V}$	-	-0.1	-	

**On Characteristics**

Drain-Source On-resistance	$R_{DS(on)}$	$I_D = 12\text{ A}, V_{GS} = 3\text{ V}, T_j = 25^\circ\text{C}$	-	0.08	0.1	$\Omega$
		$I_D = 12\text{ A}, V_{GS} = 3\text{ V}, T_j = 125^\circ\text{C}$	-	0.20	-	
Gate Threshold Voltage	$V_{GS(th)}$	$V_{DS} = 1\text{ V}, I_D = 34\text{ mA}$	0.75	1.00	1.25	V
Gate Forward Current	$I_{GFWD}$	$V_{GS} = 3\text{ V}$	-	220	-	mA
Gate Resistance	$R_G$	$f = 1\text{ MHz}, \text{ drain-source shorted}$	-	8	-	$\Omega$
	$R_{G(ON)}$	$V_{GS} > 2.7\text{ V}; \text{ See Figure 5}$	-	0.5	-	$\Omega$

**Dynamic Characteristics**

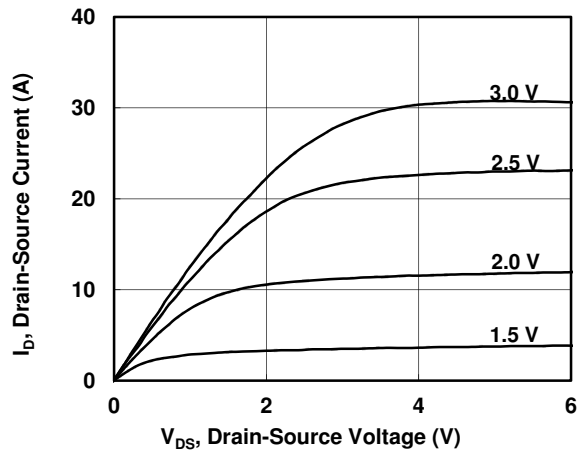
Input Capacitance	$C_{iss}$	$V_{DD} = 100\text{ V}$	-	670	-	$\text{pF}$
Output Capacitance	$C_{oss}$		-	103	-	
Reverse Transfer Capacitance	$C_{rss}$		-	97	-	
Effective Output Capacitance, energy related	$C_{o(er)}$	$V_{DS} = 0\text{ V to } 600\text{ V}, V_{GS} = 0\text{ V}$	-	60	-	

**Switching Characteristics**

Turn-on Delay	$t_{on}$	$V_{DS} = 600\text{ V}, I_D = 12\text{ A}, \text{ Inductive Load}, T_j = 25^\circ\text{C}$ Gate Driver = +15V, -10V,	-	10	-	ns
Rise Time	$t_r$		-	12	-	
Turn-off Delay	$t_{off}$		-	30	-	
Fall Time	$t_f$		-	25	-	
Turn-on Energy	$E_{on}$	See Figure 15 and application note for gate drive recommendations	-	68	-	$\mu\text{J}$
Turn-off Energy	$E_{off}$		-	87	-	
Total Switching Energy	$E_{ts}$		-	155	-	
Turn-on Delay	$t_{on}$		$V_{DS} = 600\text{ V}, I_D = 12\text{ A}, \text{ Inductive Load}, T_j = 150^\circ\text{C}$ Gate Driver = +15V, -10V,	-	10	
Rise Time	$t_r$	-		15	-	
Turn-off Delay	$t_{off}$	-		30	-	
Fall Time	$t_f$	-		25	-	
Turn-on Energy	$E_{on}$	See Figure 15 and application note for gate drive recommendations	-	82	-	$\mu\text{J}$
Turn-off Energy	$E_{off}$		-	94	-	
Total Switching Energy	$E_{ts}$		-	176	-	
Total Gate Charge	$Q_g$		$V_{DS} = 600\text{ V}, I_D = 5\text{ A}, V_{GS} = +2.5\text{ V}$	-	30	
Gate-Source Charge	$Q_{gs}$	-		1	-	
Gate-Drain Charge	$Q_{gd}$	-		24	-	

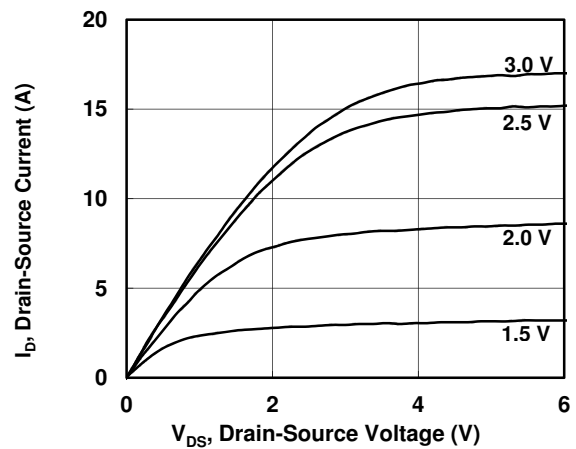
**Figure 1. Typical Output Characteristics**

$I_D = f(V_{DS}); T_j = 25\text{ }^\circ\text{C};$  parameter:  $V_{GS}$



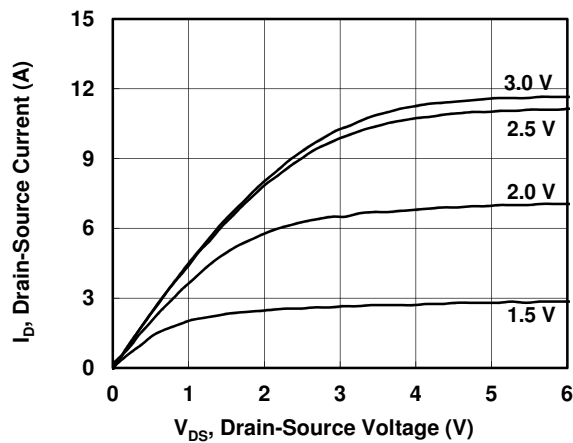
**Figure 2. Typical Output Characteristics**

$I_D = f(V_{DS}); T_j = 100\text{ }^\circ\text{C};$  parameter:  $V_{GS}$



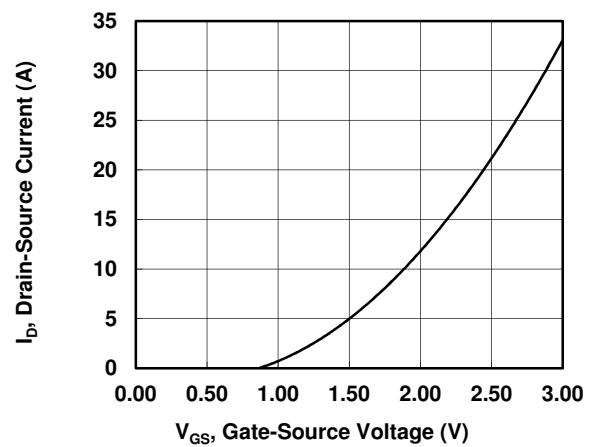
**Figure 3. Typical Output Characteristics**

$I_D = f(V_{DS}); T_j = 150\text{ }^\circ\text{C};$  parameter:  $V_{GS}$



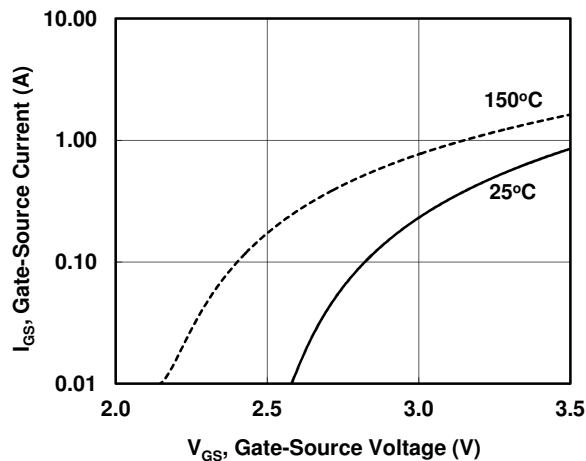
**Figure 4. Typical Transfer Characteristics**

$I_D = f(V_{GS}); V_{DS} = 5\text{ V}$



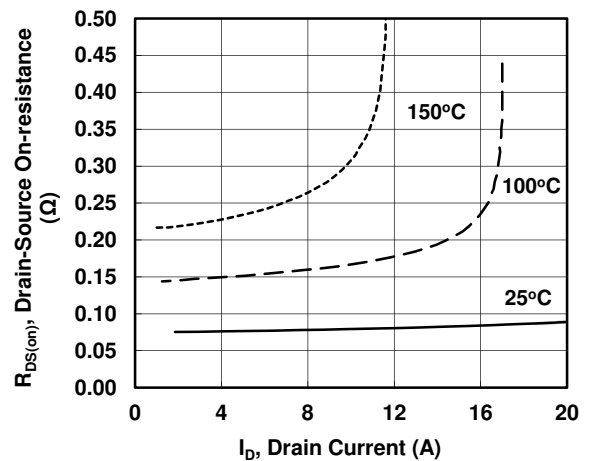
**Figure 5. Gate-Source Current**

$I_{GS} = f(V_{GS});$  parameter:  $T_j$



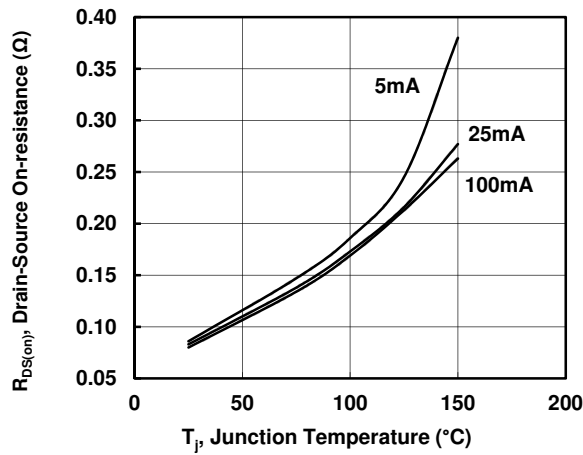
**Figure 6. Drain-Source On-resistance**

$R_{DS(on)} = f(I_D); V_{GS} = 3.0;$  parameter:  $T_j$



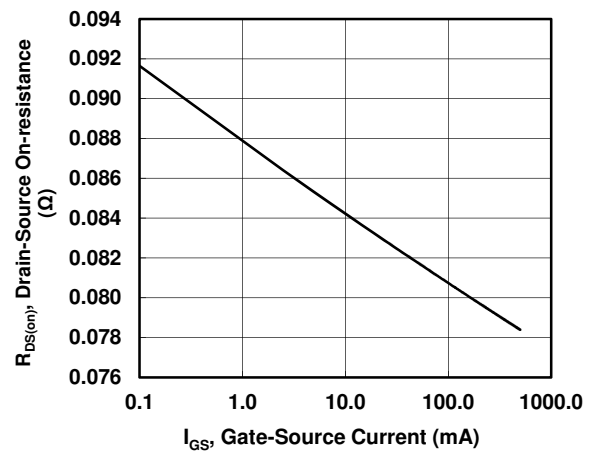
**Figure 7. Drain-Source On-resistance**

$R_{DS(ON)} = f(T_j)$ ; parameter:  $I_{GS}$



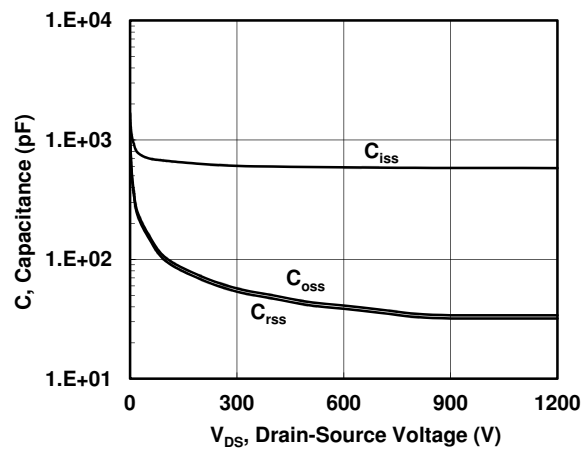
**Figure 8. Drain-Source On-resistance**

$R_{DS(ON)} = f(I_{GS})$ ;  $T_j = 25^\circ\text{C}$



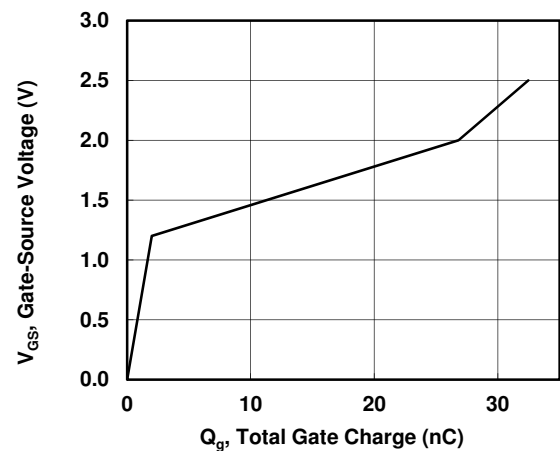
**Figure 9. Typical Capacitance**

$C = f(V_{DS})$ ;  $V_{GS} = 0\text{ V}$ ;  $f = 1\text{ MHz}$



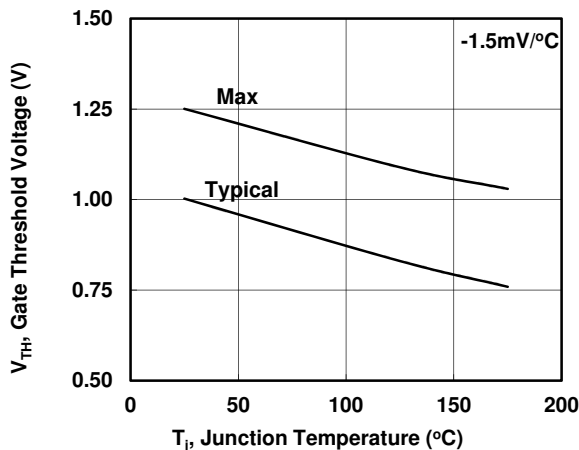
**Figure 10. Gate Charge**

$Q_g = f(V_{GS})$ ;  $V_{DS} = 600\text{ V}$ ;  $I_D = 5\text{ A}$ ;  $T_j = 25^\circ\text{C}$



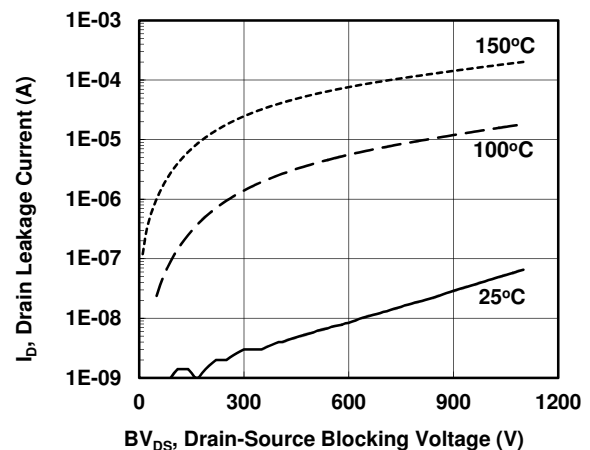
**Figure 11. Gate Threshold Voltage**

$V_{th} = f(T_j)$



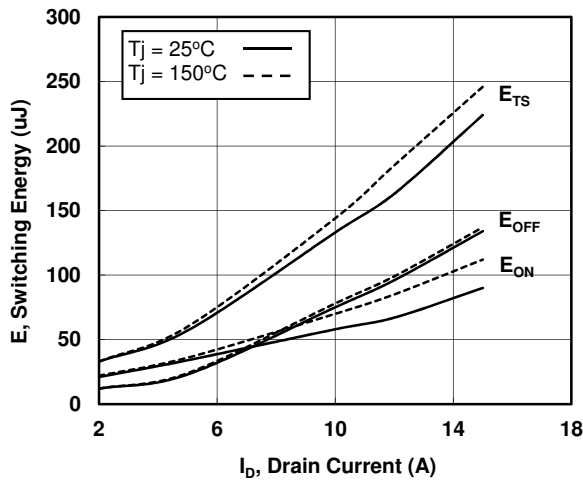
**Figure 12. Drain-Source Leakage**

$I_D = f(V_{DS})$ ;  $V_{GS} = 0\text{ V}$ ; parameter:  $T_j$



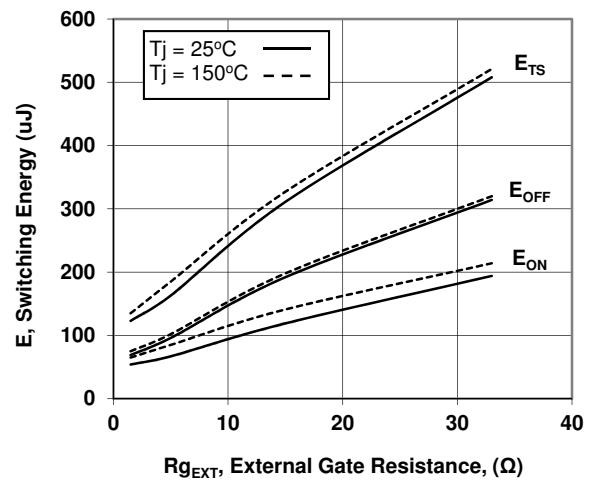
**Figure 13. Switching Energy Losses**

$E_s = f(I_D)$ ;  $V_{DS} = 600V$ ;  $GD = +15V/-10V$ ,  $R_{GEXT} = 5ohm$

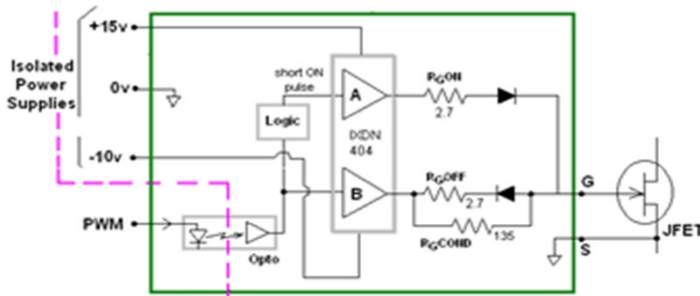


**Figure 14. Switching Energy Losses**

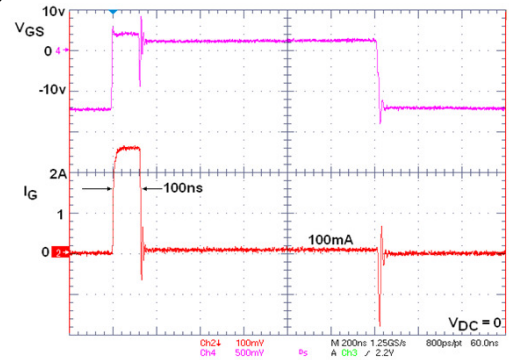
$E_s = f(R_{GEXT})$ ;  $V_{DS} = 600V$ ;  $I_D = 12A$ ,  $GD = +15V/-10V$



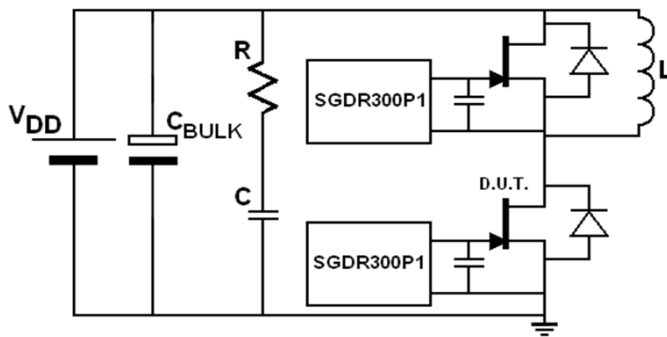
**Figure 15. Gate Driver & Switching Test Circuit**



SGDR300P1



**Figure 16. Test Circuit & Test Conditions**

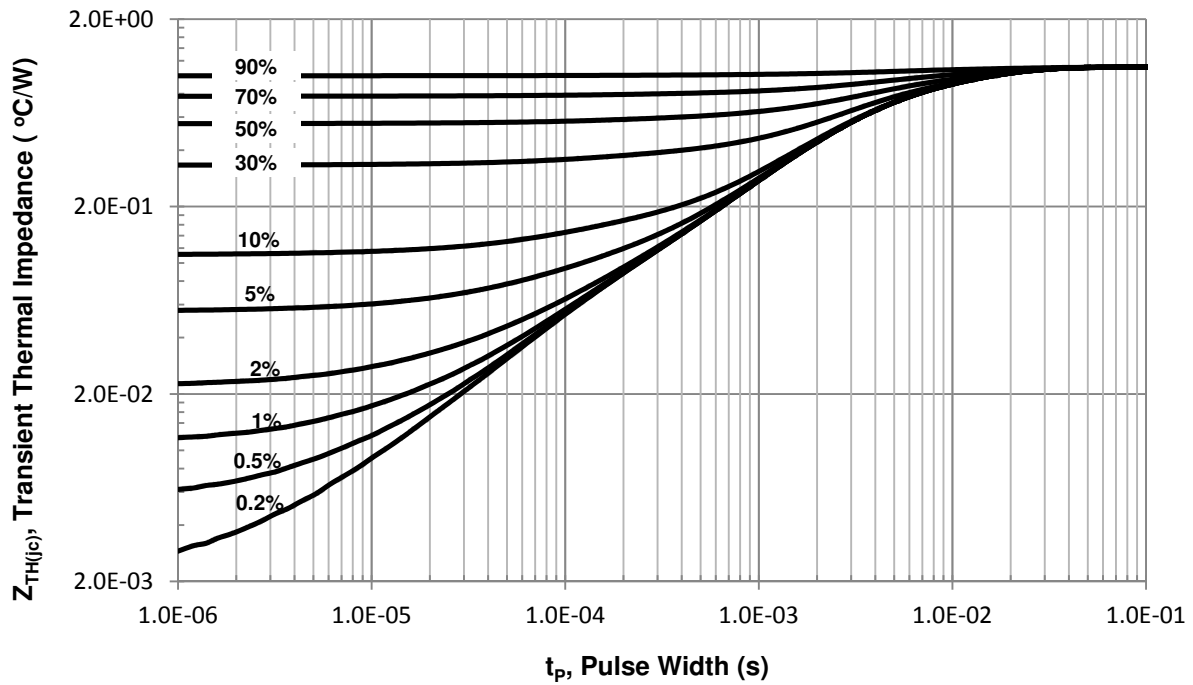


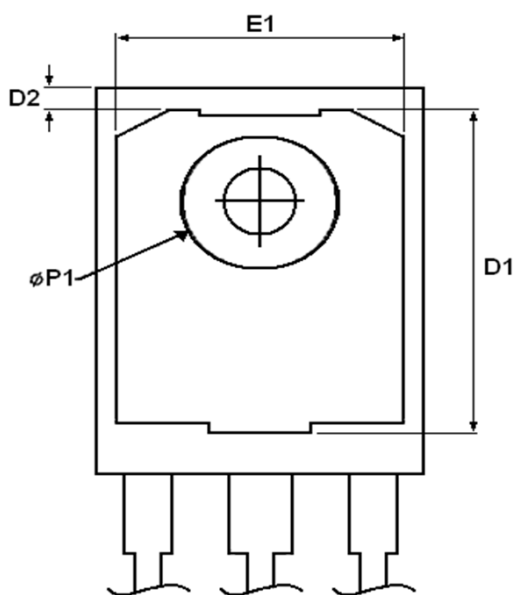
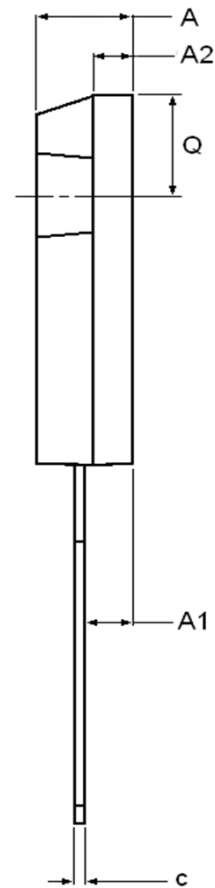
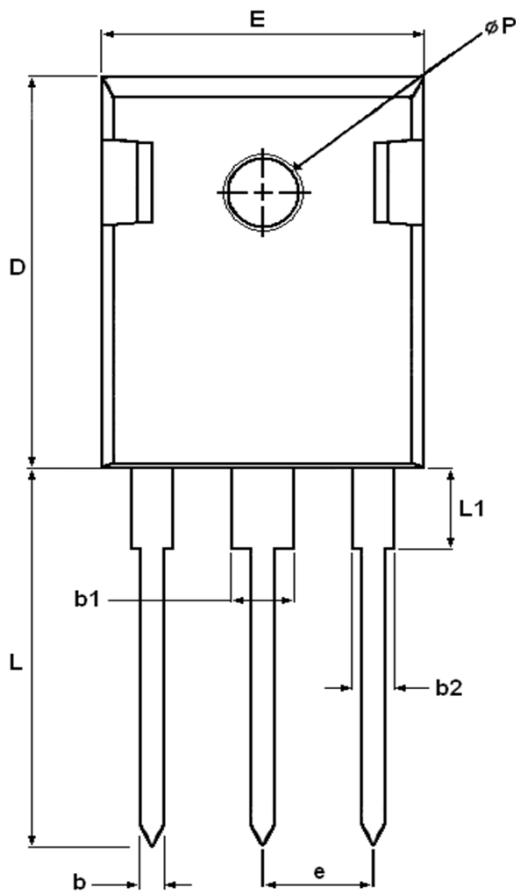
Test Conditions

- Single Device configuration
- $V_{DD} = 600V$ ,  $I_{LPK} = 12A$ ,  $T_A = 25^\circ C$
- RC snubber:  $R = 22$  and  $C = 4.7nF$
- 400uH load inductance
- Each device driven by separate SGD300P1
- Gate driver approx. 5mm from gate terminal
- 3.3nF gate-source capacitive clamp

The SGDR300P1 is a gate driver reference design available for purchase from SemiSouth. See applications note AN-SS2 for full circuit description, test results, schematics, and bill of materials. Gerber files also available upon request.

**Figure 17. Transient Thermal Impedance**  
 $Z_{th(jc)} = f(t_p)$ ; parameter: Duty Ratio





DIM	MILLIMETERS		INCHES	
	MIN	MAX	MIN	MAX
A	4.903	5.157	0.193	0.203
A1	2.273	2.527	0.090	0.100
A2	1.853	2.108	0.073	0.083
b	1.073	1.327	0.042	0.052
b1	2.873	3.381	0.113	0.133
b2	1.903	2.386	0.042	0.052
c	0.600	0.752	0.024	0.029
D	20.823	21.077	0.820	0.830
D1	17.393	17.647	0.685	0.695
D2	1.063	1.317	0.042	0.052
e	5.450		0.215	
E	15.773	16.027	0.621	0.631
E1	13.893	14.147	0.547	0.557
L	20.053	20.307	0.789	0.799
L1	4.168	4.472	0.165	0.175
Q	6.043	6.297	0.238	0.248
ØP	3.560	3.660	0.140	0.144
ØP1	7.063	7.317	0.278	0.288

Published by  
SemiSouth Laboratories, Inc.  
201 Research Boulevard  
Starkville, MS 39759 USA  
© SemiSouth Laboratories, Inc. 2011

Information in this document supersedes and replaces all information previously supplied.

Information in this document is provided solely in connection with SemiSouth products. SemiSouth Laboratories, Inc. reserves the right to make changes, corrections, modifications or improvements, to this document without notice.

No license, express or implied to any intellectual property rights is granted under this document.

Unless expressly approved in writing by an authorized representative of SemiSouth, SemiSouth products are not designed, authorized or warranted for use in military, aircraft, space, life saving, or life sustaining applications, nor in products or systems where failure or malfunction may result in personal injury, death, or property or environmental damage.