

Normally-On Trench Silicon Carbide Power JFET

Product Summary		
BV_{DS}	1200	V
$R_{DS(on)max}$	0.045	Ω

Features:

- Positive Temperature Coefficient for Ease of Paralleling
- Extremely Fast Switching with No "Tail" Current at 150 °C
- $R_{DS(on)}$ typical of 0.035 Ω
- Voltage Controlled
- Low Gate Charge
- Low Intrinsic Capacitance

Applications:

- Solar Inverter
- SMPS
- Power Factor Correction
- Induction Heating
- UPS
- Motor Drive

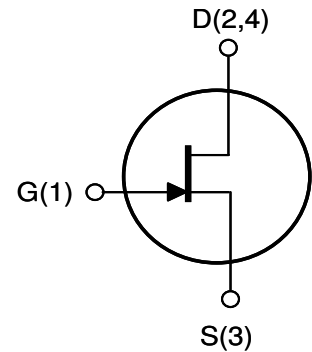
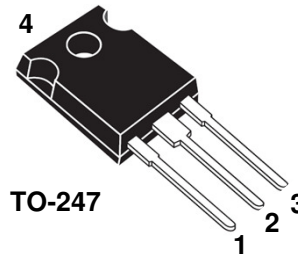

Internal Schematic

MAXIMUM RATINGS

Parameter	Symbol	Conditions	Value	Unit
Continuous Drain Current	$I_{D, TC=25}$	$T_C = 25\text{ }^\circ\text{C}$	48	A
	$I_{D, TC=100}$	$T_C = 100\text{ }^\circ\text{C}$	30	
Pulsed Drain Current ⁽¹⁾	I_{DM}	$T_j = 25\text{ }^\circ\text{C}$	140	A
Short Circuit Withstand Time	t_{SC}	$V_{DD} < 800\text{ V}, T_C < 125\text{ }^\circ\text{C}$	50	μs
Power Dissipation	P_D	$T_C = 25\text{ }^\circ\text{C}$	208	W
Gate-Source Voltage	V_{GS}	AC ⁽²⁾	-15 to +15	V
Operating and Storage Temperature	T_j, T_{stg}		-55 to +150	$^\circ\text{C}$
Lead Temperature for Soldering	T_{sold}	1/8" from case < 10 s	260	$^\circ\text{C}$

⁽¹⁾ Pulse width limited by maximum junction temperature

⁽²⁾ $R_{g(EXT)} = 1\text{ ohm}, t_p \leq 200\text{ns}$, see Figure 5 for static conditions

THERMAL CHARACTERISTICS

Parameter	Symbol	Value		Unit
		Typ	Max	
Thermal Resistance, junction-to-case	$R_{th,JC}$	-	0.6	$^\circ\text{C} / \text{W}$
Thermal Resistance, junction-to-ambient	$R_{th,JA}$	-	50	

ELECTRICAL CHARACTERISTICS

Parameter	Symbol	Conditions	Value			Unit
			Min	Typ	Max	

Off Characteristics

Drain-Source Blocking Voltage	BV_{DS}	$V_{GS} = -15\text{ V}, I_D = 1200\ \mu\text{A}$	1200	-	-	V
Total Drain Leakage Current	I_{DSS}	$V_{DS} = 1200\text{ V}, V_{GS} = -15\text{ V}, T_j = 25^\circ\text{C}$	-	20	-	μA
		$V_{DS} = 1200\text{ V}, V_{GS} = -15\text{ V}, T_j = 150^\circ\text{C}$	-	200	-	
Total Gate Reverse Leakage	I_{GSS}	$V_{GS} = -15\text{ V}, V_{DS} = 0\text{ V}$	-	-0.2	-0.6	mA
		$V_{GS} = -15\text{ V}, V_{DS} = 1200\text{ V}$	-	-0.2	-	

On Characteristics

Drain-Source On-resistance	$R_{DS(on)}$	$I_D = 30\text{ A}, V_{GS} = 2\text{ V}, T_j = 25^\circ\text{C}$	-	0.035	0.045	Ω
		$I_D = 30\text{ A}, V_{GS} = 2\text{ V}, T_j = 100^\circ\text{C}$	-	0.06	-	
Gate Threshold Voltage	$V_{GS(th)}$	$V_{DS} = 1\text{ V}, I_D = 70\text{ mA}$	-	-5	-	V
Gate Forward Current	I_{GFWD}	$V_{GS} = 2\text{ V}$	-	41	-	μA
Gate Resistance	R_G	$f = 1\text{ MHz}, \text{ drain-source shorted}$	-	4	-	Ω
	$R_{G(on)}$	$V_{GS} > 2.7\text{ V}; \text{ See Figure 5}$	-	0.25	-	Ω

Dynamic Characteristics

Input Capacitance	C_{iss}	$V_{DD} = 100\text{ V}, V_{GS} = -15\text{ V}, f = 100\text{ kHz}$	-	510	-	pF
Output Capacitance	C_{oss}		-	160	-	
Reverse Transfer Capacitance	C_{rss}		-	160	-	
Effective Output Capacitance, energy related	$C_{o(er)}$	$V_{DS} = 0\text{ V to } 600\text{ V}, V_{GS} = -15\text{ V}$	-	100	-	

Switching Characteristics

Turn-on Delay	t_{on}	$V_{DS} = 600\text{ V}, I_D = 30\text{ A}, \text{ Inductive Load}, T_j = 25^\circ\text{C}$ Gate Driver = +15V, -15V, $R_{g(EXT)} = 1\ \Omega$	-	TBD	-	ns
Rise Time	t_r		-	TBD	-	
Turn-off Delay	t_{off}		-	TBD	-	
Fall Time	t_f		-	TBD	-	
Turn-on Energy	E_{on}		-	TBD	-	
Turn-off Energy	E_{off}	$V_{DS} = 600\text{ V}, I_D = 30\text{ A}, \text{ Inductive Load}, T_j = 150^\circ\text{C}$ Gate Driver = +15V, -15V, $R_{g(EXT)} = 1\ \Omega$	-	TBD	-	μJ
Total Switching Energy	E_{ts}		-	TBD	-	
Turn-on Delay	t_{on}		-	TBD	-	
Rise Time	t_r		-	TBD	-	
Turn-off Delay	t_{off}		-	TBD	-	
Fall Time	t_f	$V_{DS} = 600\text{ V}, I_D = 15\text{ A}, V_{GS} = +2.5\text{ V}$	-	TBD	-	nC
Turn-on Energy	E_{on}		-	65	-	
Turn-off Energy	E_{off}		-	4	-	
Total Switching Energy	E_{ts}		-	54	-	
Total Gate Charge	Q_g					
Gate-Source Charge	Q_{gs}					
Gate-Drain Charge	Q_{gd}					

Figure 1. Typical Output Characteristics

$I_D = f(V_{DS}); T_j = 25\text{ }^\circ\text{C}; \text{parameter: } V_{GS}$

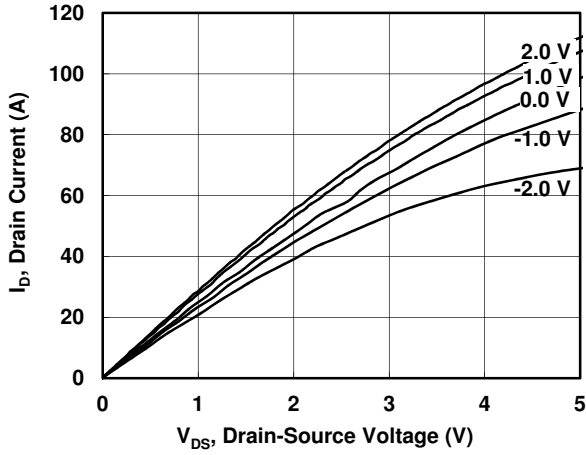

Figure 2. Typical Output Characteristics

$I_D = f(V_{DS}); T_j = 100\text{ }^\circ\text{C}; \text{parameter: } V_{GS}$

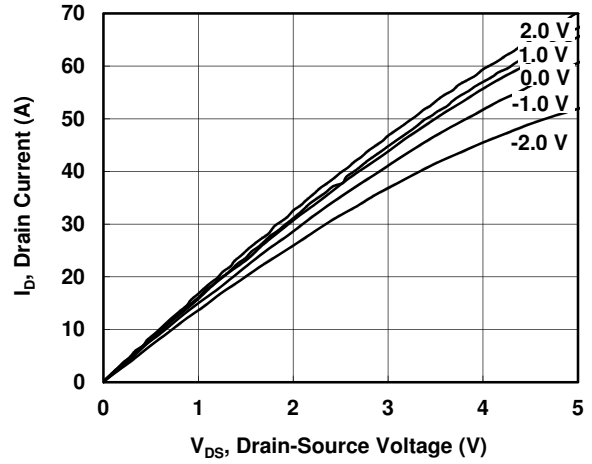

Figure 3. Typical Output Characteristics

$I_D = f(V_{DS}); T_j = 150\text{ }^\circ\text{C}; \text{parameter: } V_{GS}$

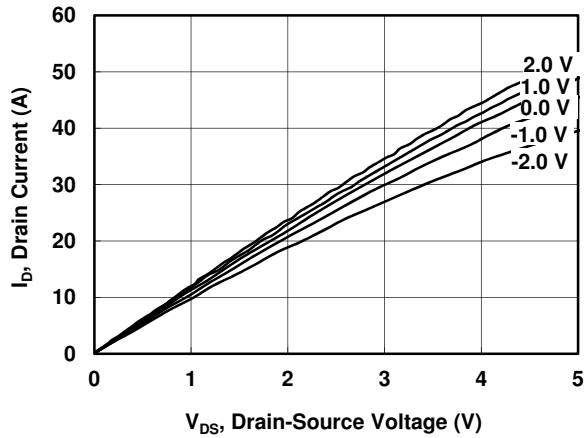

Figure 4. Typical Transfer Characteristics

$I_D = f(V_{GS}); V_{DS} = 5\text{ V}; T_j = 25\text{ }^\circ\text{C}$

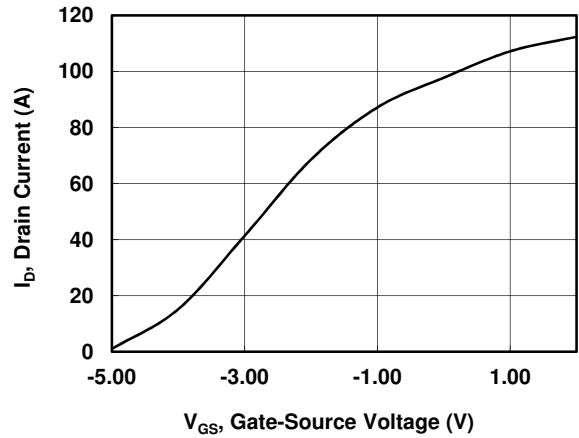

Figure 5. Gate Current

$I_G = f(V_{GS}); \text{parameter: } T_j$

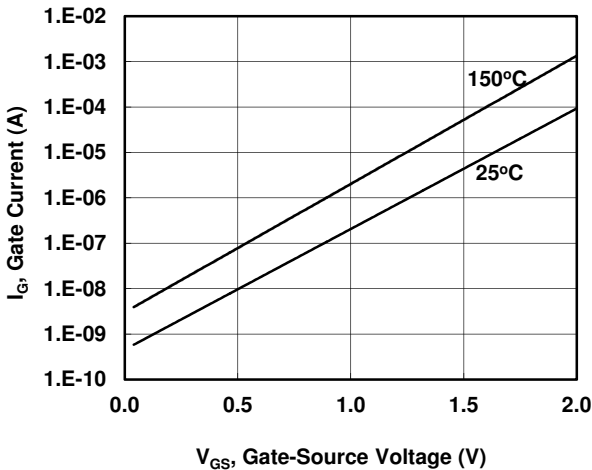

Figure 6. Drain-Source On-resistance

$R_{DS(on)} = f(I_D); V_{GS} = 2.0; \text{parameter: } T_j$

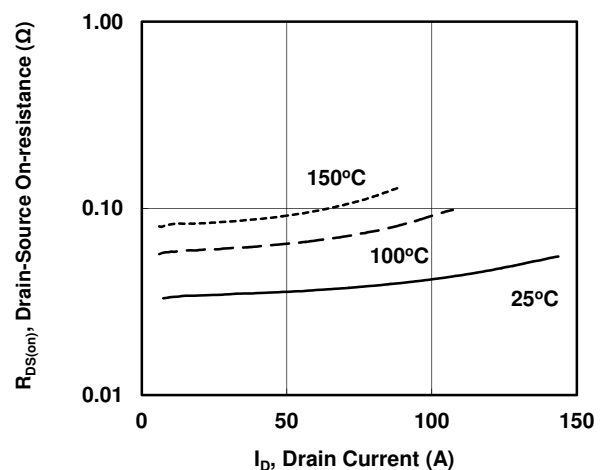

Figure 7. Drain-Source On-resistance

$R_{DS(on)} = f(T_j); I_D = 30A; \text{parameter: } V_{GS}$

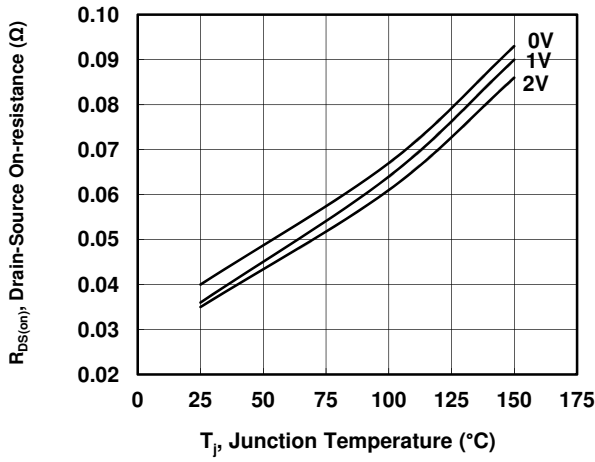

Figure 8. Drain-Source On-resistance

$R_{DS(on)} = f(V_{GS}); I_D = 30A; T_i = 25^\circ C$

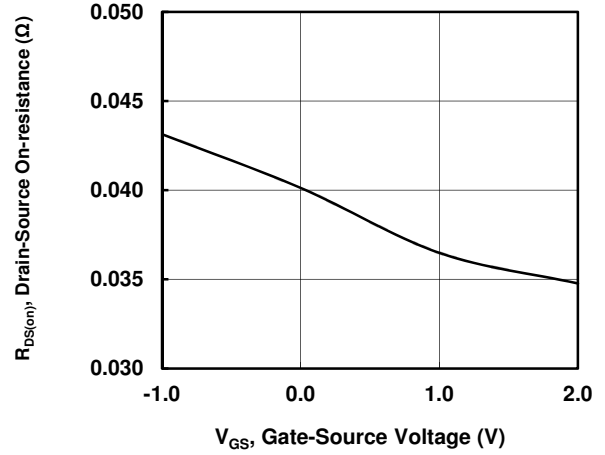

Figure 9. Typical Capacitance

$C = f(V_{DS}); V_{GS} = -15V; f = 100\text{ kHz}$

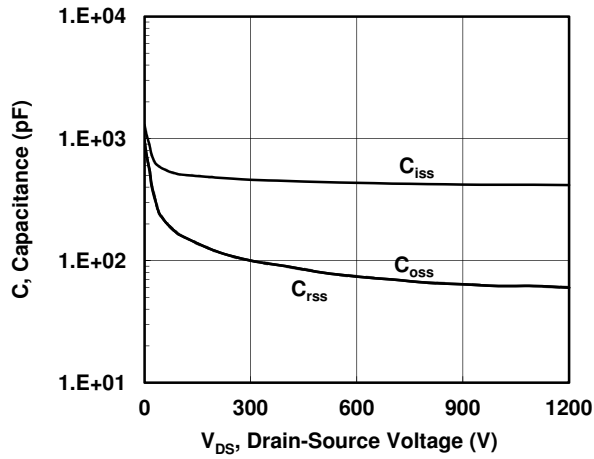
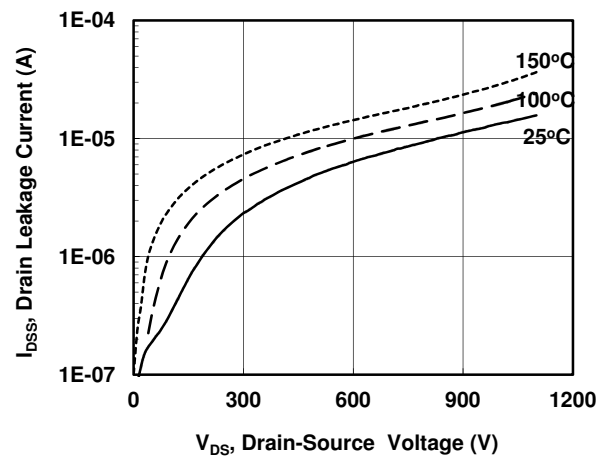
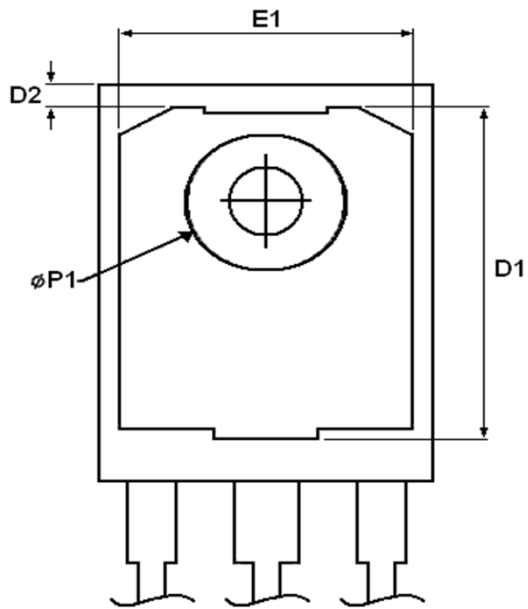
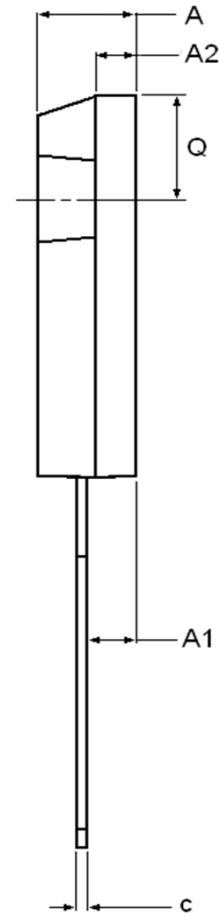
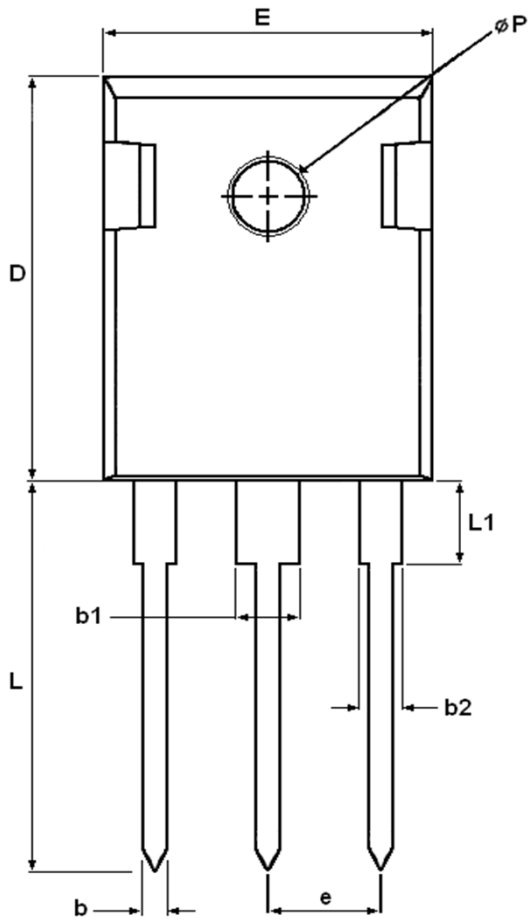

Figure 10. Drain-Source Leakage

$I_{DSS} = f(V_{DS}); V_{GS} = -15V; \text{parameter: } T_j$





DIM	MILLIMETERS		INCHES	
	MIN	MAX	MIN	MAX
A	4.903	5.157	0.193	0.203
A1	2.273	2.527	0.090	0.100
A2	1.853	2.108	0.073	0.083
b	1.073	1.327	0.042	0.052
b1	2.873	3.381	0.113	0.133
b2	1.903	2.386	0.042	0.052
c	0.600	0.752	0.024	0.029
D	20.823	21.077	0.820	0.830
D1	17.393	17.647	0.685	0.695
D2	1.063	1.317	0.042	0.052
e	5.450		0.215	
E	15.773	16.027	0.621	0.631
E1	13.893	14.147	0.547	0.557
L	20.053	20.307	0.789	0.799
L1	4.168	4.472	0.165	0.175
Q	6.043	6.297	0.238	0.248
ØP	3.560	3.660	0.140	0.144
ØP1	7.063	7.317	0.278	0.288

Published by
SemiSouth Laboratories, Inc.
201 Research Boulevard
Starkville, MS 39759 USA
© SemiSouth Laboratories, Inc. 2011

Information in this document supersedes and replaces all information previously supplied.

Information in this document is provided solely in connection with SemiSouth products. SemiSouth Laboratories, Inc. reserves the right to make changes, corrections, modifications or improvements, to this document without notice.

No license, express or implied to any intellectual property rights is granted under this document.

Unless expressly approved in writing by an authorized representative of SemiSouth, SemiSouth products are not designed, authorized or warranted for use in military, aircraft, space, life saving, or life sustaining applications, nor in products or systems where failure or malfunction may result in personal injury, death, or property or environmental damage.