

**2SC1570,  
1571,  
1571L**



2003A

NPN Epitaxial Planar Silicon Transistors

T-29-15

## Very Low Noise Amp Applications

©431D

The 2SC1570, 1571, 1571L are developed as very low-noise transistors and are especially suited for use in equalizer first stage of high-grade type stereo sets.

Absolute Maximum Ratings at Ta=25°C		2SC1570	2SC1571	2SC1571L	unit
Collector to Base Voltage	V <sub>CB0</sub>	55	40	40	V
Collector to Emitter Voltage	V <sub>CE0</sub>	50	35	35	V
Emitter to Base Voltage	V <sub>EBO</sub>		5		V
Collector Current	I <sub>C</sub>		100		mA
Allowable Power Dissipation	P <sub>C</sub>		200		mW
Junction Temperature	T <sub>J</sub>		125		°C
Storage Temperature	T <sub>stg</sub>		-55 to +150		°C

Electrical Characteristics at Ta=25°C		min	typ	max	unit
Collector Cutoff Current	I <sub>CB0</sub> V <sub>CB</sub> =18V, I <sub>E</sub> =0			0.1	uA
Emitter Cutoff Current	I <sub>EBO</sub> V <sub>EB</sub> =3V, I <sub>C</sub> =0			0.1	uA
DC Current Gain	h <sub>FE</sub> V <sub>CE</sub> =6V, I <sub>C</sub> =1mA	160*		960*	
Gain Bandwidth Product	f <sub>T</sub> V <sub>CE</sub> =6V, I <sub>C</sub> =1mA		100		MHz
Output Capacitance	c <sub>ob</sub> V <sub>CB</sub> =6V, f=1MHz		3		pF
C-E Saturation Voltage	V <sub>CE(sat)</sub> I <sub>C</sub> =50mA, I <sub>B</sub> =5mA			0.5	V
Base to Emitter Voltage	V <sub>BE</sub> V <sub>CE</sub> =2V, I <sub>C</sub> =1mA	0.58	0.80		V
C-B Breakdown Voltage	V(BR)CBO I <sub>C</sub> =10uA, I <sub>B</sub> =0				V
				[C1570] 55	
				[C1571, 1571L] 40	
C-E Breakdown Voltage	V(BR)CEO I <sub>C</sub> =1mA, R <sub>BE</sub> =∞				V
				[C1570] 50	
				[C1571, 1571L] 35	
E-B Breakdown Voltage	V(BR)EBO I <sub>E</sub> =10uA, I <sub>C</sub> =0			5	V
Noise Voltage	at test circuit [C1570, 1571]			40	mV
	V <sub>CC</sub> =30V, I <sub>C</sub> =1mA [C1571L]			65	mV
	R <sub>g</sub> =56kohm, V <sub>G</sub> =77dB (at 1kHz)				
Noise Peak Level	" " [C1570, 1571]			280	mV
	" " [C1571L]			450	mV

\*:The 2SC1570, 1571, 1571L are classified by 1mA h<sub>FE</sub> as follows:

160	F	320	280	G	560	480	H	960
-----	---	-----	-----	---	-----	-----	---	-----

### Noise Test Circuit

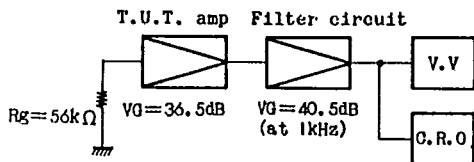

### Case Outline 2003A (unit:mm)

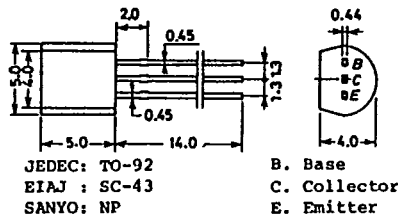

2SC1570, 1571, 1571L

(T-29-15)

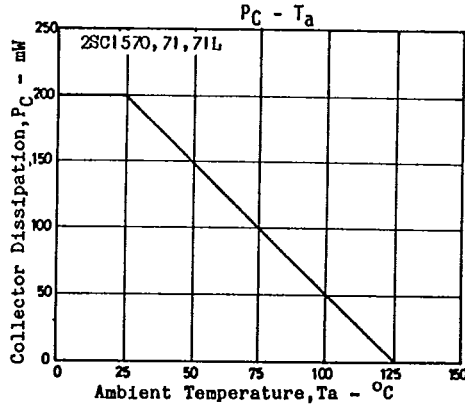
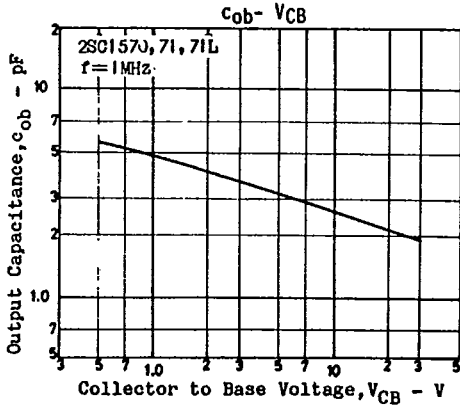
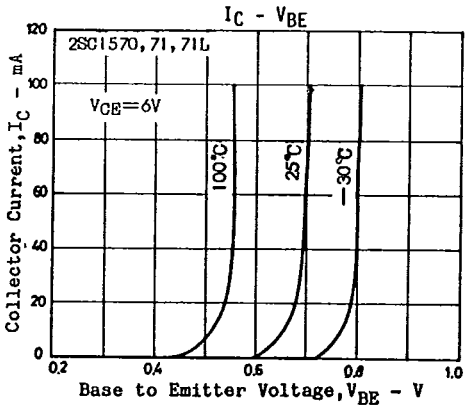
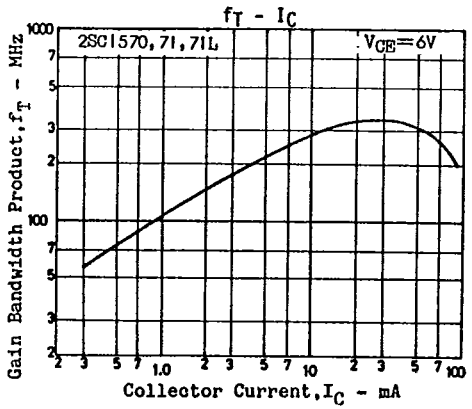
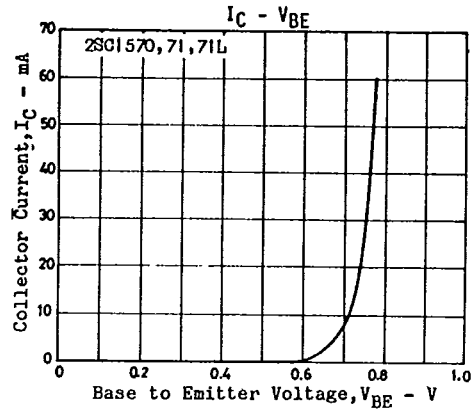
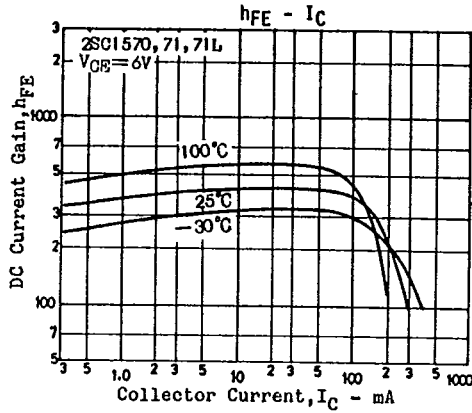
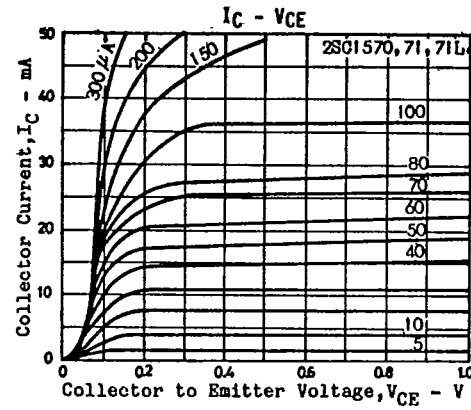
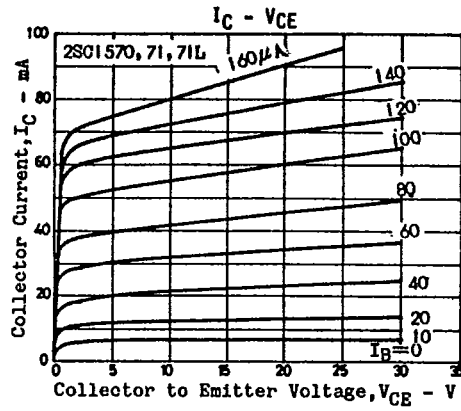

2SC1570, 1571, 1571L

(T-29-15)

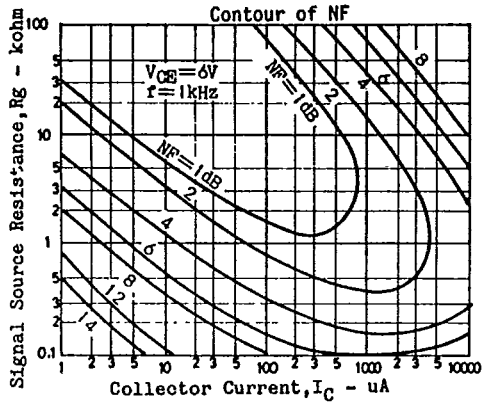
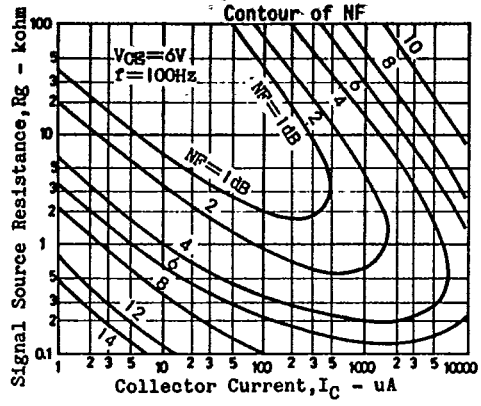
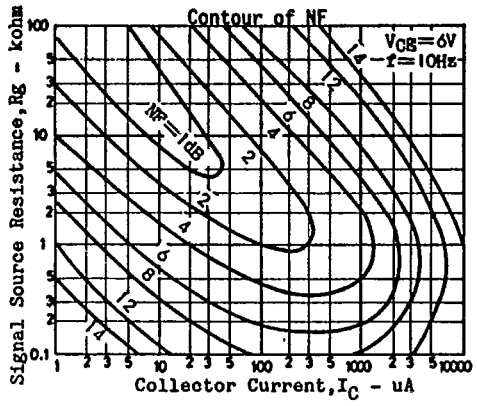

T-91-20

# CASE OUTLINES AND ATTACHMENTS

- All of Sanyo Transistor case outlines are illustrated below.
- All dimensions are in mm, and dimensions which are not followed by min. or max. are represented by typical values.
- No marking is indicated.

Case Outline-[2003A]

unit:mm

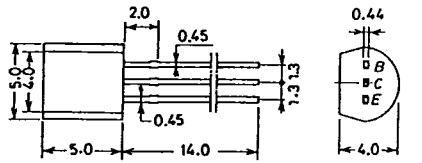

JEDEC: TO-92  
EIAJ: SC-43  
SANYO: NP

B. Base  
C. Collector  
E. Emitter

Case Outline-[2009A]

unit:mm

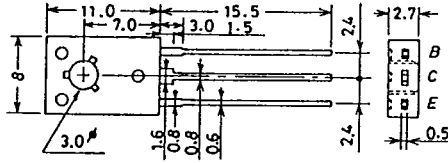

JEDEC: TO-126

B: Base  
C: Collector  
E: Emitter

Case Outline-[2004A]

unit:mm

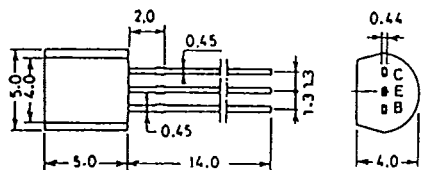

JEDEC: TO-92  
EIAJ: SC-43  
SANYO: NP

C. Collector  
E. Emitter  
B. Base

Case Outline-[2010A]

unit:mm

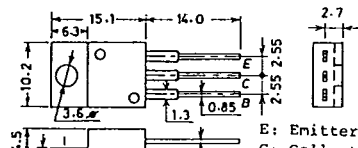

JEDEC: TO-220AB  
EIAJ: SC-46

E: Emitter  
C: Collector  
B: Base

Case Outline-[2005A]

unit:mm

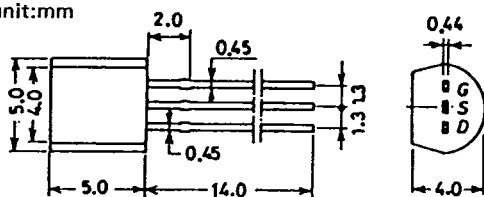

JEDEC: TO-92  
EIAJ: SC-43  
SANYO: NP

G: Gate  
S: Source  
D: Drain  
B: Base  
C: Collector

Case Outline-[2012]

unit:mm

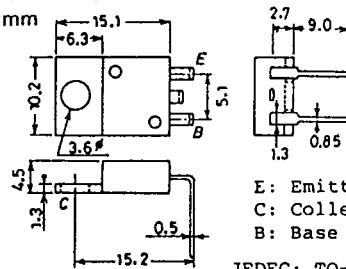

JEDEC: TO-220AA  
EIAJ: SC-45

E: Emitter  
C: Collector  
B: Base

Case Outline-[2006A]

unit:mm

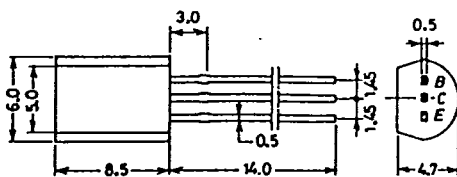

EIAJ: SC-51  
SANYO: MP

B: Base  
C: Collector  
E: Emitter

Case Outline-[2013]

unit:mm

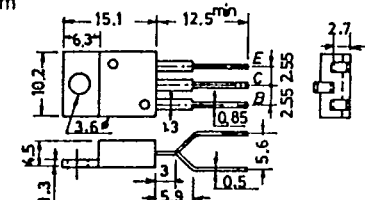

JEDEC TO-220

B: Base  
C: Collector  
E: Emitter

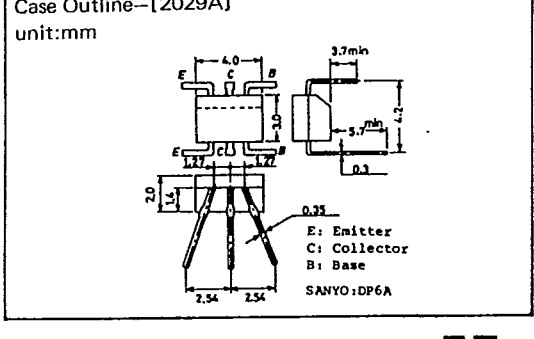
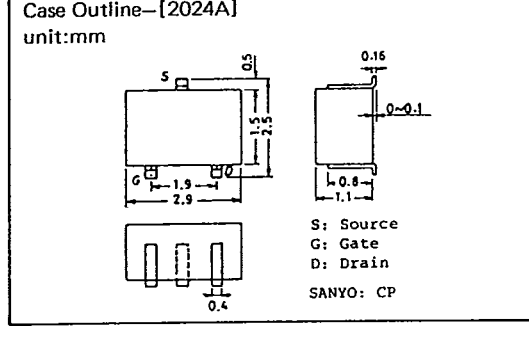
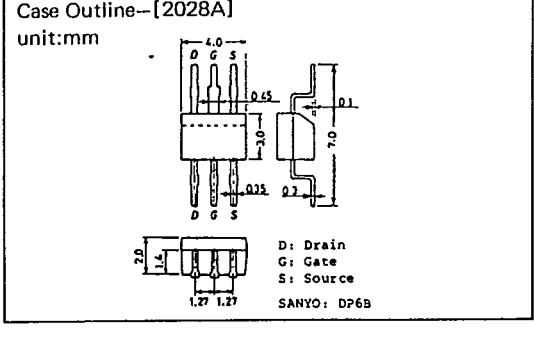
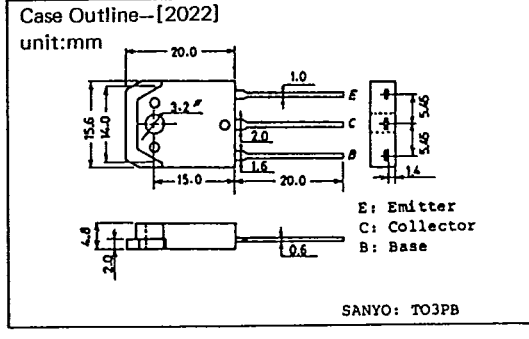
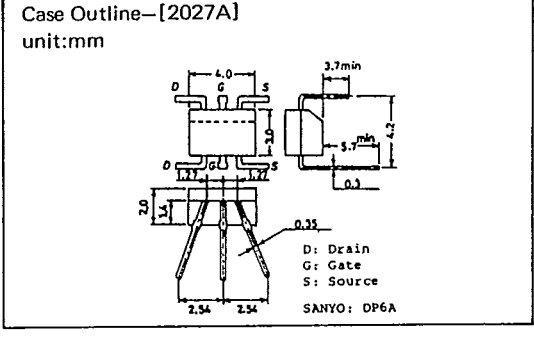
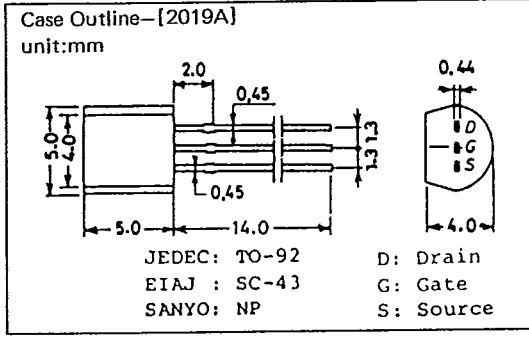
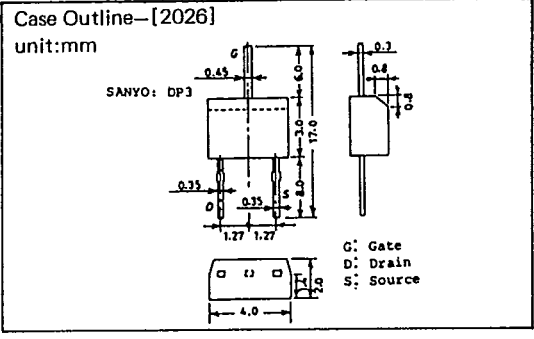
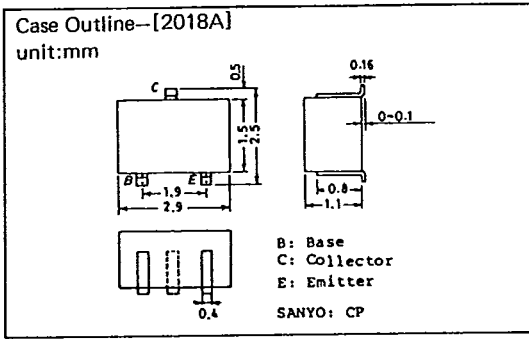
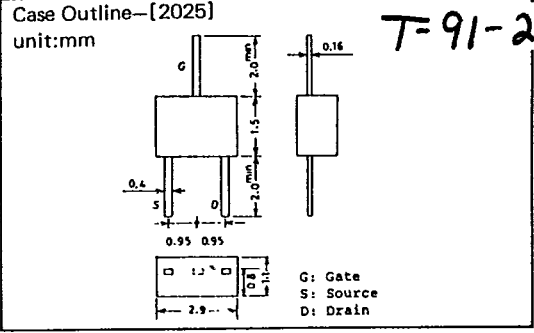
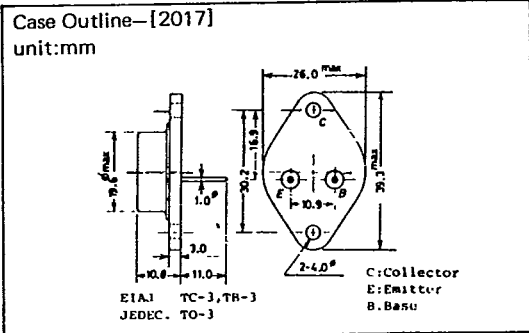



T-91-20

