



N-Channel JFETs

2N4391	PN4391	SST4391
2N4392	PN4392	SST4392
2N4393	PN4393	SST4393

PRODUCT SUMMARY				
Part Number	$V_{GS(off)}$ (V)	$r_{DS(on)}$ Max (Ω)	$I_{D(off)}$ Typ (μ A)	t_{ON} Typ (ns)
2N/PN/SST4391	-4 to -10	30	5	4
2N/PN/SST4392	-2 to -5	60	5	4
2N/PN/SST4393	-0.5 to -3	100	5	4

FEATURES

- Low On-Resistance: 4391 < 30 Ω
- Fast Switching— t_{ON} : 4 ns
- High Off-Isolation: $I_{D(off)}$ with Low Leakage
- Low Capacitance: < 3.5 pF
- Low Insertion Loss

BENEFITS

- Low Error Voltage
- High-Speed Analog Circuit Performance
- Negligible “Off-Error,” Excellent Accuracy
- Good Frequency Response, Low Glitches
- Eliminates Additional Buffering

APPLICATIONS

- Analog Switches
- Choppers
- Sample-and-Hold
- Normally “On” Switches
- Current Limiters
- Commutators

DESCRIPTION

The 2N/PN/SST4391 series features many of the superior characteristics of JFETs which make it a good choice for demanding analog switching applications and for specialized amplifier circuits.

The 2N series hermetically-sealed TO-206AA (TO-18) can be available with processing per MIL-S-19500 (see Military Information). Both the PN, TO-226AA (TO-92), and SST, TO-236 (SOT-23), series are available in tape-and-reel for automated assembly (see Packaging Information). For similar dual products, see the 2N5564/5565/5566 data sheet.

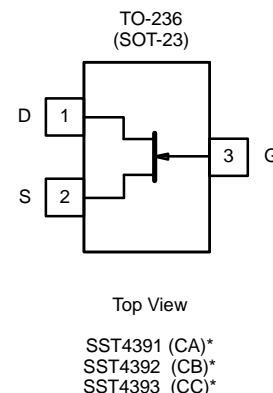
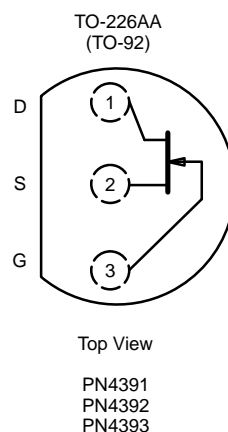
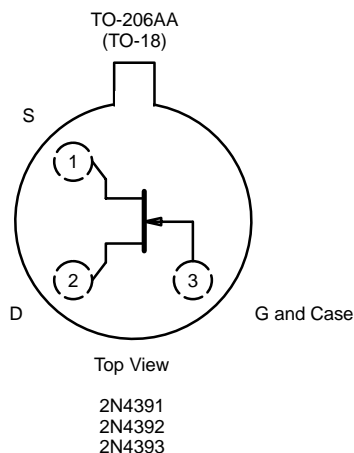

*Marking Code for TO-236

For applications information see AN104 and AN106



ABSOLUTE MAXIMUM RATINGS

Gate-Drain, Gate-Source Voltage:

(2N/PN Prefixes) -40 V
(SST Prefix) -35 V

Gate Current 50 mA

Lead Temperature 300 °C

Storage Temperature : (2N Prefix) -65 to 200 °C
(PN/SST Prefixes) -55 to 150 °C

Operating Junction Temperature :

(2N Prefix) -55 to 200 °C
(PN/SST Prefixes) -55 to 150 °C

Power Dissipation : (2N Prefix)^a (T_C = 25 °C) 1800 mW
(PN/SST Prefixes)^b 350 mW

Notes

- a. Derate 10 mW/°C above 25 °C
- b. Derate 2.8 mW/°C above 25 °C

SPECIFICATIONS (T _A = 25 °C UNLESS OTHERWISE NOTED)											
Parameter	Symbol	Test Conditions	Typ ^a	Limits						Unit	
				4391		4392		4393			
				Min	Max	Min	Max	Min	Max		
Static											
Gate-Source Breakdown Voltage	V _{(BR)GSS}	I _G = -1 μA, V _{DS} = 0 V	-55	-40		-40		-40		V	
Gate-Source Cutoff Voltage	V _{GS(off)}	V _{DS} = 20 V	2N/PN: I _D = 1 nA		-4	-10	-2	-5	-0.5	-3	
		V _{DS} = 15 V	SST: I _D = 10 nA								
Saturation Drain Current ^b	I _{DSS}	V _{DS} = 20 V, V _{GS} = 0 V	2N	50	150	25	75	5	30	mA	
			PN	50	150	25	100	5	60		
			SST	50		25		5			
Gate Reverse Current	I _{GSS}	V _{GS} = -20 V V _{DS} = 0 V	2N/SST	-5		-100		-100		-100	pA
			PN	-5		-1000		-1000		-1000	
			2N: T _A = 150 °C	-13		-200		-200		-200	nA
			PN: T _A = 100 °C	-1		-200		-200		-200	
SST: T _A = 125 °C	-3										
Gate Operating Current	I _G	V _{DG} = 15 V, I _D = 10 mA	-5								
Drain Cutoff Current	I _{D(off)}	V _{DS} = 20 V	2N: V _{GS} = -5 V	5						100	pA
			2N: V _{GS} = -7 V	5			100				
			2N: V _{GS} = -12 V	5		100					
			PN: V _{GS} = -5 V	0.005					1	nA	
			PN: V _{GS} = -7 V	0.005				1			
			PN: V _{GS} = -12 V	0.005		1					
		SST V _{DS} = 10 V, V _{GS} = -10 V	5		100		100		100	pA	
		V _{DS} = 20 V T _A = 150 °C	2N: V _{GS} = -5 V	13						200	nA
			2N: V _{GS} = -7 V	13				200			
			2N: V _{GS} = -12 V	13		200					
V _{DS} = 20 V T _A = 100 °C	PN: V _{GS} = -5 V	1						200			
	PN: V _{GS} = -7 V	1				200					
	PN: V _{GS} = -12 V	1		200							
V _{DS} = 10 V T _A = 125 °C	SST: V _{GS} = -10 V	3									
Drain-Source On-Voltage	V _{DS(on)}	V _{GS} = 0 V	I _D = 3 mA	0.25					0.4	V	
			I _D = 6 mA	0.3			0.4				
			I _D = 12 mA	0.35		0.4					
Drain-Source On-Resistance	r _{DS(on)}	V _{GS} = 0 V, I _D = 1 mA			30		60		100	Ω	
Gate-Source Forward Voltage	V _{GS(F)}	I _G = 1 mA V _{DS} = 0 V	2N	0.7		1		1		1	V
			PN/SST	0.7							



SPECIFICATIONS (T _A = 25 °C UNLESS OTHERWISE NOTED)											
Parameter	Symbol	Test Conditions	Typ ^a	Limits						Unit	
				4391		4392		4393			
				Min	Max	Min	Max	Min	Max		
Dynamic											
Common-Source Forward Transconductance	g _{fs}	V _{DS} = 20 V, I _D = 1 mA, f = 1 kHz	6							mS	
Common-Source Output Conductance	g _{os}		25							μS	
Drain-Source On-Resistance	r _{DS(on)}	V _{GS} = 0 V, I _D = 0 mA, f = 1 kHz			30		60		100	Ω	
Common-Source Input Capacitance	C _{iss}	V _{DS} = 20 V, V _{GS} = 0 V f = 1 MHz	2N	12		14		14		14	
			PN	12		16		16		16	
			SST	13							
Common-Source Reverse Transfer Capacitance	C _{rss}	V _{DS} = 0 V f = 1 MHz	2N: V _{GS} = -5 V	3.3						3.5	pF
			2N: V _{GS} = -7 V	3.2				3.5			
			2N: V _{GS} = -12 V	2.8		3.5					
			PN: V _{GS} = -5 V	3.5						5	
			PN: V _{GS} = -7 V	3.4				5			
			PN: V _{GS} = -12 V	3.0		5					
			SST: V _{GS} = -5 V	3.6							
			SST: V _{GS} = -12 V	3.1							
Equivalent Input Noise Voltage	e _n	V _{DS} = 10 V, I _D = 10 mA f = 1 kHz	3							nV/ √Hz	
Switching											
Turn-On Time	t _{d(on)}	V _{DD} = 10 V V _{GS(H)} = 0 V See Switching Circuit	2N/PN	2		15		15		15	ns
	t _r		SST	2							
Turn-Off Time	t _{d(off)}		2N/PN	2		5		5		5	
			SST	2							
	t _f		2N/PN	6		20		35		50	
			SST	6							
		2N/PN	13		15		20		30		
		SST	13								

Notes

- a. Typical values are for DESIGN AID ONLY, not guaranteed nor subject to production testing.
- b. Pulse test: PW ≤ 300 μs duty cycle ≤ 3%.

NCB

TYPICAL CHARACTERISTICS ($T_A = 25^\circ\text{C}$ UNLESS OTHERWISE NOTED)

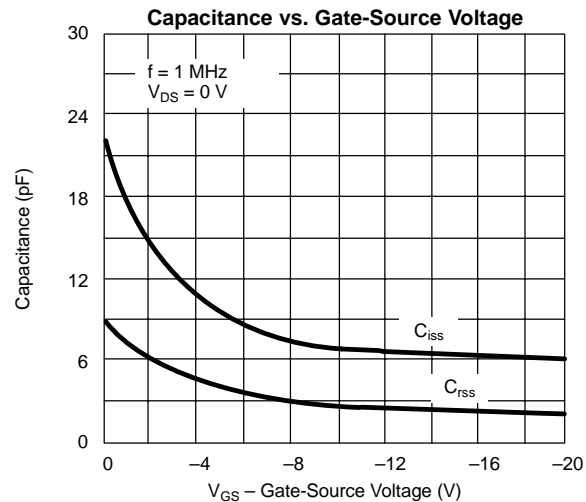
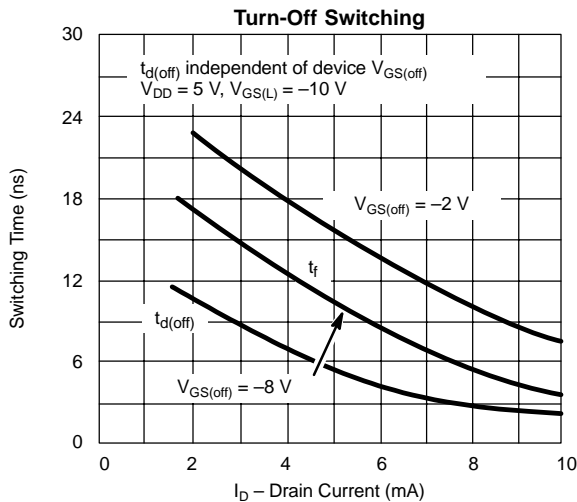
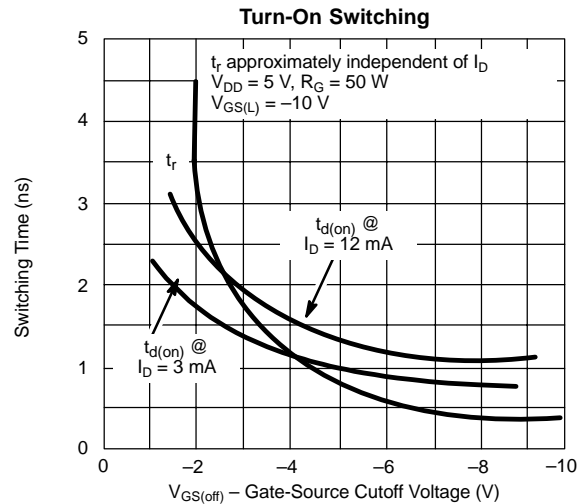
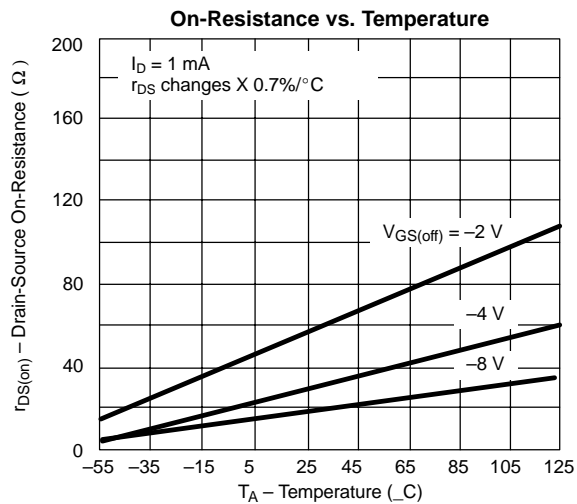
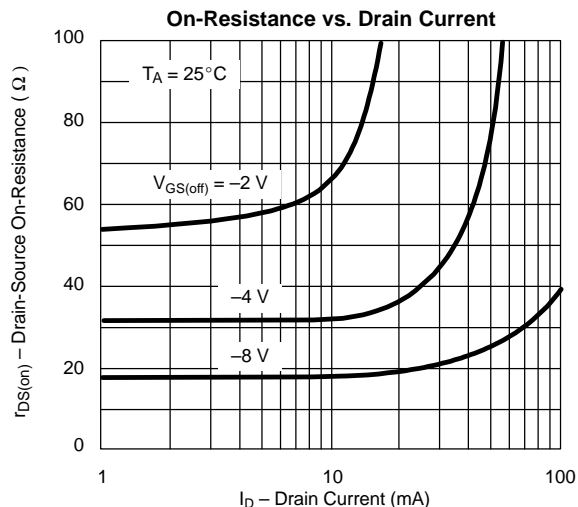
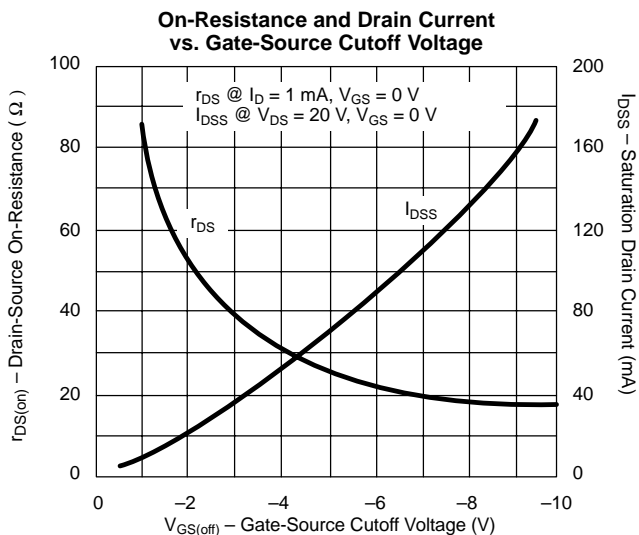



TYPICAL CHARACTERISTICS ($T_A = 25^\circ\text{C}$ UNLESS OTHERWISE NOTED)

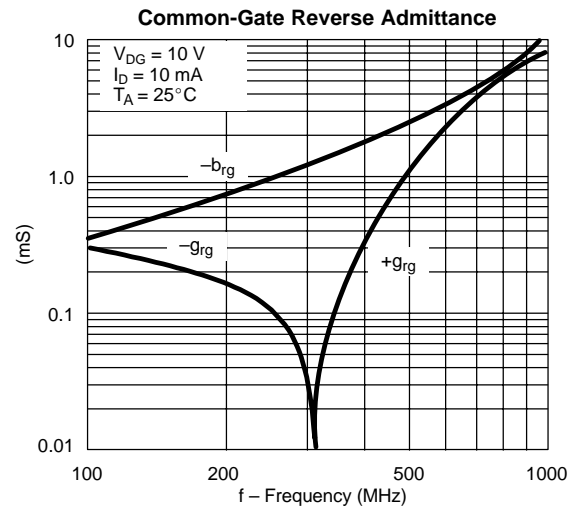
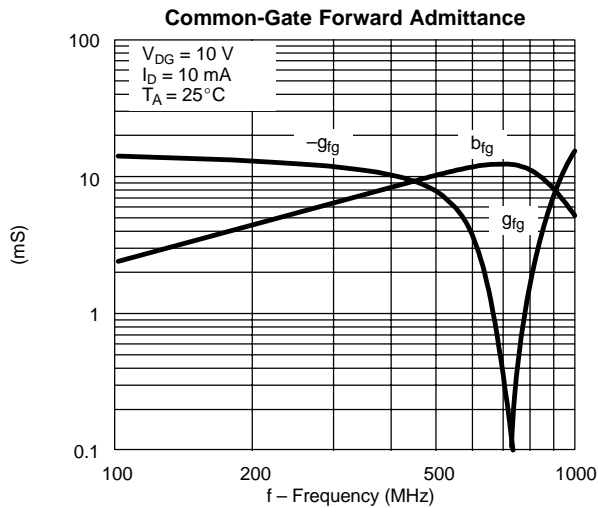
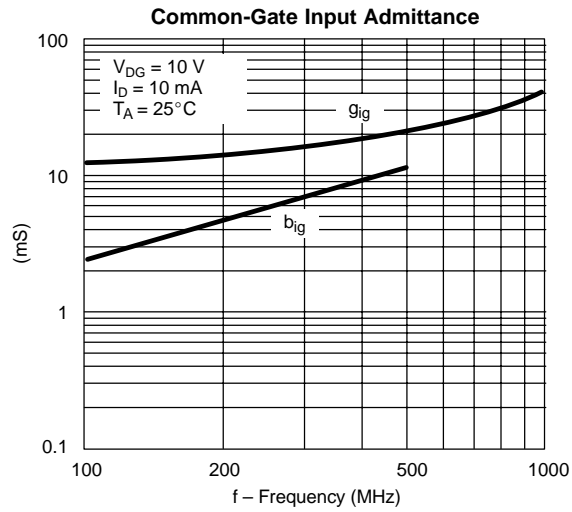
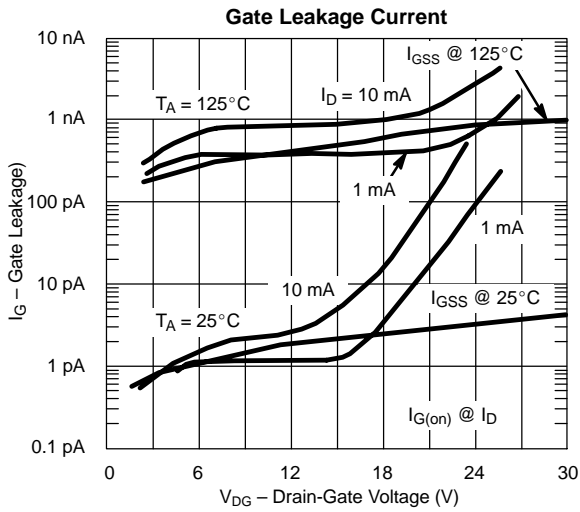
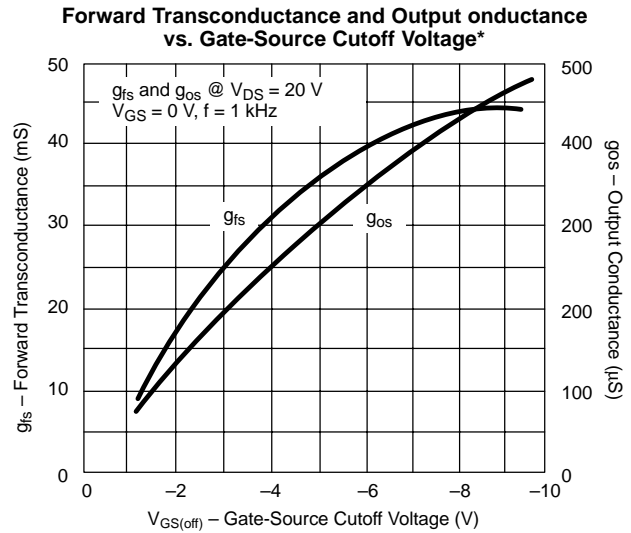
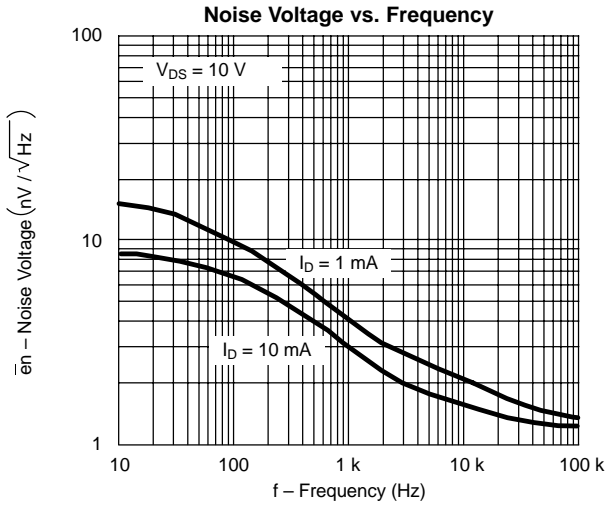

TYPICAL CHARACTERISTICS ($T_A = 25^\circ\text{C}$ UNLESS OTHERWISE NOTED)

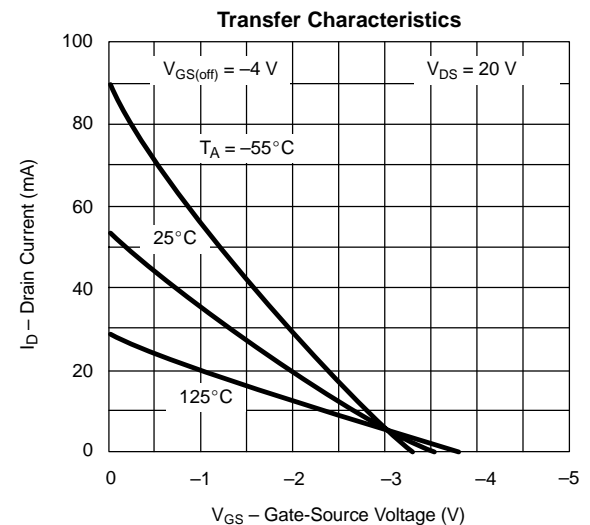
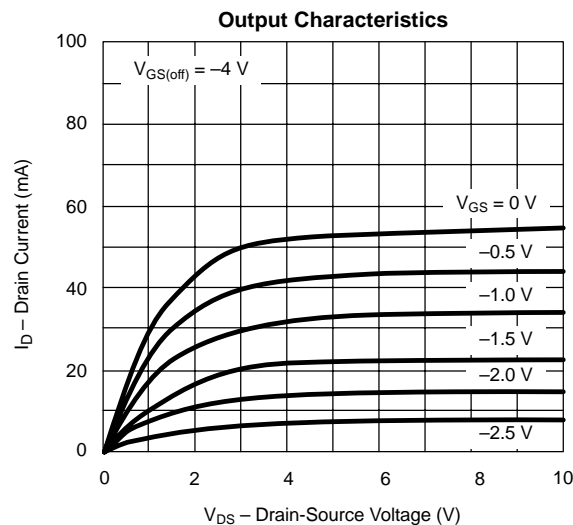
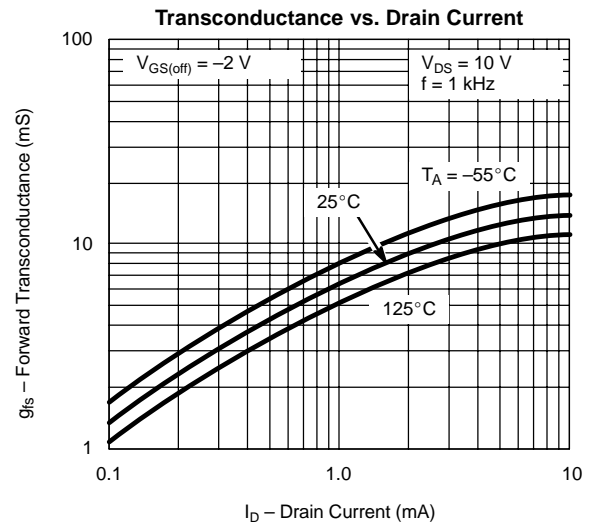
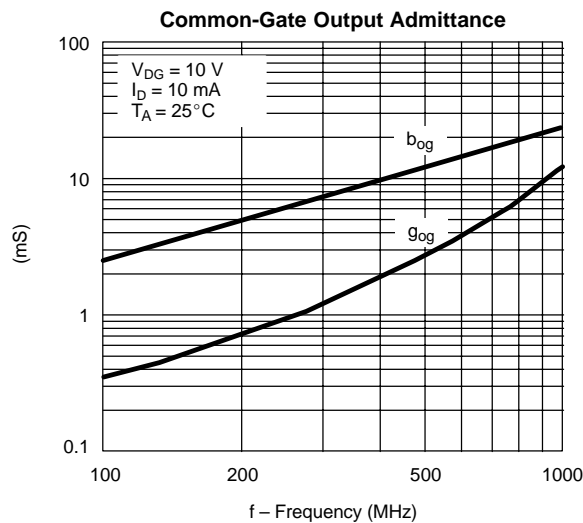

SWITCHING TIME TEST CIRCUIT			
	4391	4392	4393
$V_{GS(L)}$	-12 V	-7 V	-5 V
R_L^*	800 Ω	1600 Ω	3000 Ω
$I_{D(on)}$	12 mA	6 mA	3 mA

*Non-inductive

INPUT PULSE

Rise Time < 1 ns
Fall Time < 1 ns
Pulse Width 100 ns
PRF 1 MHz

SAMPLING SCOPE

Rise Time 0.4 ns
Input Resistance 10 M Ω
Input Capacitance 1.5 pF

See Typical Characteristics curves for changes.

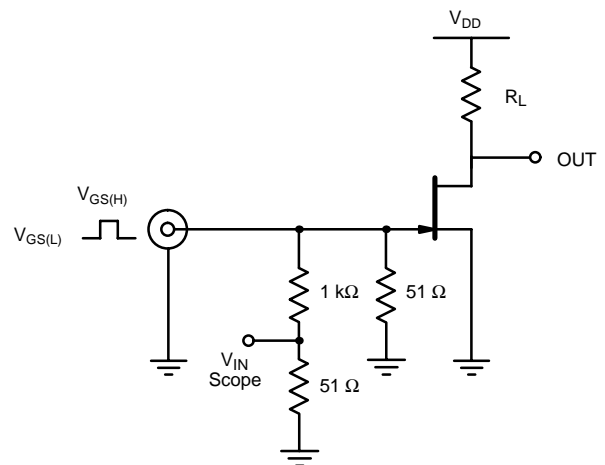

This datasheet has been download from:

www.datasheetcatalog.com

Datasheets for electronics components.