

General Purpose Transistors

PNP Silicon Annular Hermetic Transistors

Designed for high-speed switching circuits, DC to VHF amplifier applications and complementary circuitry.

- High DC Current Gain Specified — 0.1 to 500 mAdc
- High Current-Gain — Bandwidth Product —
 $f_T = 200 \text{ MHz (Min) @ } I_C = 50 \text{ mAdc}$
- Low Collector-Emitter Saturation Voltage —
 $V_{CE(sat)} = 0.4 \text{ Vdc (Max) @ } I_C = 150 \text{ mAdc}$
- 2N2904A thru 2N2907, A Complement to NPN 2N2219, A, 2N2222, A

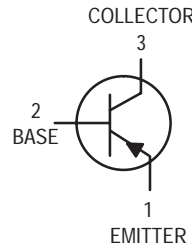

2N2904A* thru 2N2907,A*

*2N2904A, 2N2905A and 2N2907A are
Motorola Preferred Devices

MAXIMUM RATINGS

Rating	Symbol	Non-A Suffix	A-Suffix	Unit
Collector-Emitter Voltage	V_{CEO}	-40	-60	Vdc
Collector-Base Voltage	V_{CBO}	-60		Vdc
Emitter-Base Voltage	V_{EBO}	-5.0		Vdc
Collector Current — Continuous	I_C	-600		mAdc
		2N2904A 2N2905,A	2N2906A 2N2907,A	
Total Device Dissipation @ $T_A = 25^\circ\text{C}$ Derate above 25°C	P_D	600 3.43	400 2.28	mW mW/ $^\circ\text{C}$
Total Device Dissipation @ $T_C = 25^\circ\text{C}$ Derate above 25°C	P_D	3.0 17.2	1.2 6.85	Watts mW/ $^\circ\text{C}$
Operating and Storage Junction Temperature Range	T_J, T_{stg}	-65 to +200		$^\circ\text{C}$

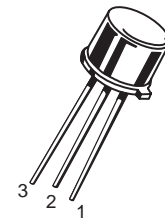

2N2904A/2N2905,A
CASE 79-04, STYLE 1
TO-39 (TO-205AD)



2N2906A/2N2907,A
CASE 22-03, STYLE 1
TO-18 (TO-206AA)

THERMAL CHARACTERISTICS

Characteristic	Symbol	Max		Unit
		2N2904A 2N2905,A	2N2906A 2N2907,A	
Thermal Resistance, Junction to Ambient	$R_{\theta JA}$	292	438	$^\circ\text{C/W}$
Thermal Resistance, Junction to Case	$R_{\theta JC}$	58	146	$^\circ\text{C/W}$

ELECTRICAL CHARACTERISTICS ($T_A = 25^\circ\text{C}$ unless otherwise noted)

Characteristic	Symbol	Min	Typ	Max	Unit
----------------	--------	-----	-----	-----	------

OFF CHARACTERISTICS

Collector-Emitter Breakdown Voltage ⁽¹⁾ ($I_C = -10 \text{ mAdc}, I_B = 0$)	Non-A Suffix A-Suffix	$V_{(BR)CEO}$	-40 -60	— —	— —	Vdc
Collector-Base Breakdown Voltage ($I_C = -10 \text{ }\mu\text{Adc}, I_E = 0$)		$V_{(BR)CBO}$	-60	—	—	Vdc
Emitter-Base Breakdown Voltage ($I_E = -10 \text{ }\mu\text{Adc}, I_C = 0$)		$V_{(BR)EBO}$	-5.0	—	—	Vdc
Collector Cutoff Current ($V_{CE} = -30 \text{ Vdc}, V_{EB} = -0.5 \text{ Vdc}$)		I_{CEX}	—	—	-50	nAdc
Collector Cutoff Current ($V_{CB} = -50 \text{ Vdc}, I_E = 0$)	Non-A Suffix A-Suffix	I_{CBO}	— —	— —	-0.02 -0.01	μAdc
($V_{CB} = -50 \text{ Vdc}, I_E = 0, T_A = 150^\circ\text{C}$)	Non-A Suffix A-Suffix		— —	— —	-20 -10	
Base Current ($V_{CE} = -30 \text{ Vdc}, V_{EB} = -0.5 \text{ Vdc}$)		I_B	—	—	-50	nAdc

1. Pulse Test: Pulse Width $\leq 300 \text{ }\mu\text{s}$, Duty Cycle $\leq 2.0\%$.

Preferred devices are Motorola recommended choices for future use and best overall value.

(Replaces 2N2904/D)

LIFETIME BUY

LAST SHIP 21/03/00
LAST ORDER 23/09/99

2N2904A thru 2N2907,A

ELECTRICAL CHARACTERISTICS ($T_A = 25^\circ\text{C}$ unless otherwise noted) (Continued)

Characteristic	Symbol	Min	Typ	Max	Unit
ON CHARACTERISTICS					
DC Current Gain ($I_C = -0.1\text{ mAdc}$, $V_{CE} = -10\text{ Vdc}$)	h_{FE}	2N2905, 2N2907	35	—	—
		2N2904A, 2N2906A	40	—	—
		2N2905A, 2N2907A	75	—	—
($I_C = -1.0\text{ mAdc}$, $V_{CE} = -10\text{ Vdc}$)		2N2905, 2N2907	25	—	—
		2N2904A, 2N2906A	40	—	—
		2N2905A, 2N2907A	100	—	—
($I_C = -10\text{ mAdc}$, $V_{CE} = -10\text{ Vdc}$)	2N2905, 2N2907	75	—	—	
	2N2904A, 2N2906A	40	—	—	
	2N2905A, 2N2907A	100	—	—	
($I_C = -150\text{ mAdc}$, $V_{CE} = -10\text{ Vdc}$) ⁽¹⁾	2N2904A, 2N2906A	40	—	120	
	2N2905,A, 2N2907,A	100	—	300	
($I_C = -500\text{ mAdc}$, $V_{CE} = -10\text{ Vdc}$) ⁽¹⁾	2N2905, 2N2907	30	—	—	
	2N2904A, 2N2906A	40	—	—	
	2N2905A, 2N2907A	50	—	—	
Collector–Emitter Saturation Voltage ⁽¹⁾ ($I_C = -150\text{ mAdc}$, $I_B = -15\text{ mAdc}$) ($I_C = -500\text{ mAdc}$, $I_B = -50\text{ mAdc}$)	$V_{CE(sat)}$	—	—	-0.4 -1.6	Vdc
Base–Emitter Saturation Voltage ⁽¹⁾ ($I_C = -150\text{ mAdc}$, $I_B = -15\text{ mAdc}$) ($I_C = -500\text{ mAdc}$, $I_B = -50\text{ mAdc}$)	$V_{BE(sat)}$	—	—	-1.3 -2.6	Vdc

DYNAMIC CHARACTERISTICS

Current–Gain — Bandwidth Product ⁽²⁾ ($I_C = -50\text{ mAdc}$, $V_{CE} = -20\text{ Vdc}$, $f = 100\text{ MHz}$)	f_T	200	—	—	MHz
Output Capacitance ($V_{CB} = -10\text{ Vdc}$, $I_E = 0$, $f = 1.0\text{ MHz}$)	C_{ob}	—	—	8.0	pF
Input Capacitance ($V_{EB} = -2.0\text{ Vdc}$, $I_C = 0$, $f = 1.0\text{ MHz}$)	C_{ib}	—	—	30	pF

SWITCHING CHARACTERISTICS

Turn–On Time	$(V_{CC} = -30\text{ Vdc}$, $I_C = -150\text{ mAdc}$, $I_{B1} = -15\text{ mAdc}$) (Figure 15a)	t_{on}	—	26	45	ns
Delay Time		t_d	—	6.0	10	
Rise Time		t_r	—	20	40	
Turn–Off Time	$(V_{CC} = -6.0\text{ Vdc}$, $I_C = -150\text{ mAdc}$, $I_{B1} = I_{B2} = -15\text{ mAdc}$) (Figure 15b)	t_{off}	—	70	100	ns
Storage Time		t_s	—	50	80	
Fall Time		t_f	—	20	30	

1. Pulse Test: Pulse Width $\leq 300\ \mu\text{s}$, Duty Cycle $\leq 2.0\%$.
2. f_T is defined as the frequency at which $|h_{fe}|$ extrapolates to unity.

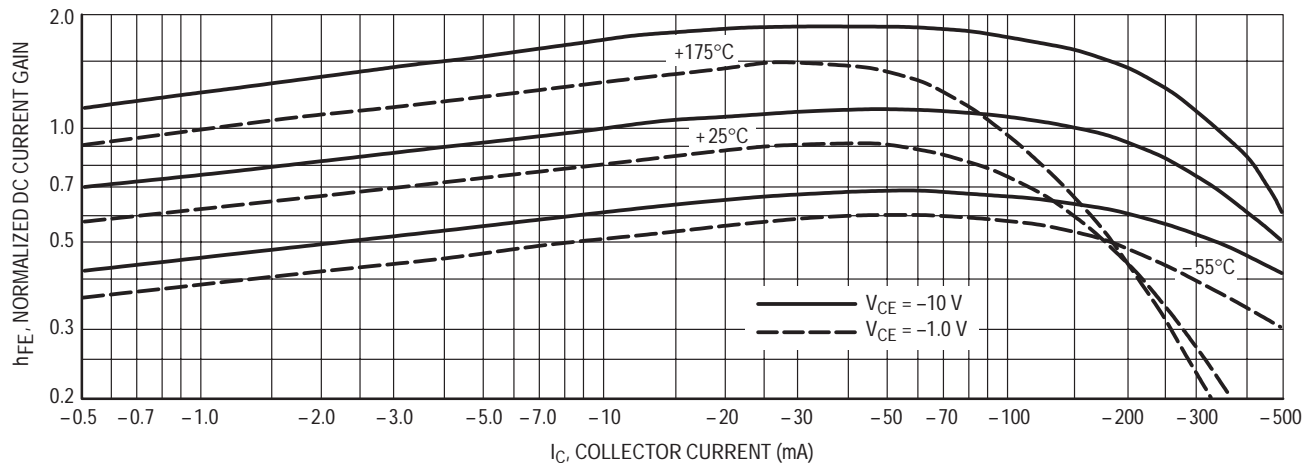

Figure 1. Normalized DC Current Gain

LAST SHIP 21/03/00
LAST ORDER 23/09/99

LIFETIME BUY

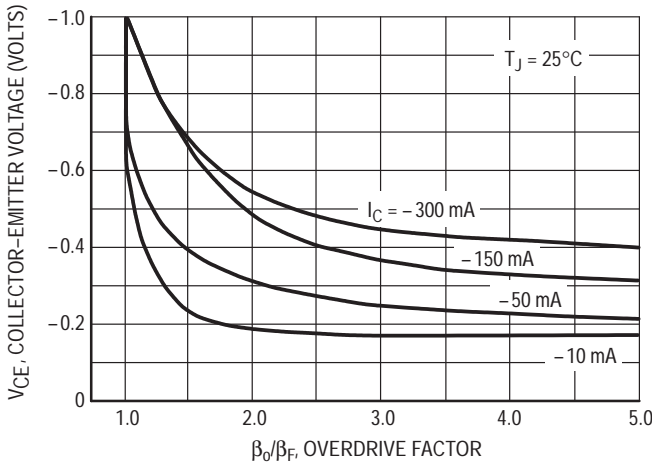

Figure 2. Normalized Collector Saturation Region

This graph shows the effect of base current on collector current. β_0 (current gain at the edge of saturation) is the current gain of the transistor at 1 volt, and β_F (forced gain) is the ratio of I_C/I_{BF} in a circuit.

EXAMPLE: For type 2N2905, estimate a base current (I_{BF}) to ensure saturation at a temperature of 25°C and a collector current of 150 mA.

Observe that at $I_C = 150$ mA an overdrive factor of at least 3 is required to drive the transistor well into the saturation region. From Figure 1, it is seen that h_{FE} @ 1 volt is approximately 0.6 of h_{FE} @ 10 volts. Using the guaranteed minimum of 100 @ 150 mA and 10 V, $\beta_0 = 60$ and substituting values in the overdrive equation, we find:

$$\frac{\beta_0}{\beta_F} = \frac{h_{FE} @ 1.0 \text{ V}}{I_C/I_{BF}} \quad 3 = \frac{60}{150/I_{BF}} \quad I_{BF} \approx 7.5 \text{ mA}$$

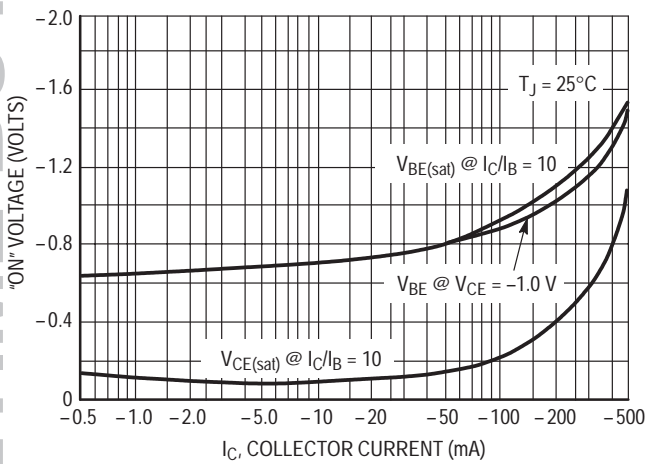

Figure 3. "On" Voltages

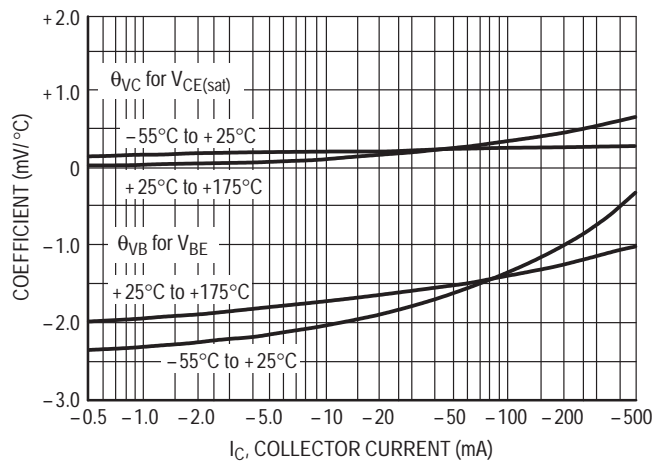

Figure 4. Temperature Coefficients

SMALL-SIGNAL CHARACTERISTICS
NOISE FIGURE

$V_{CE} = 10 \text{ V}, T_A = 25^\circ\text{C}$

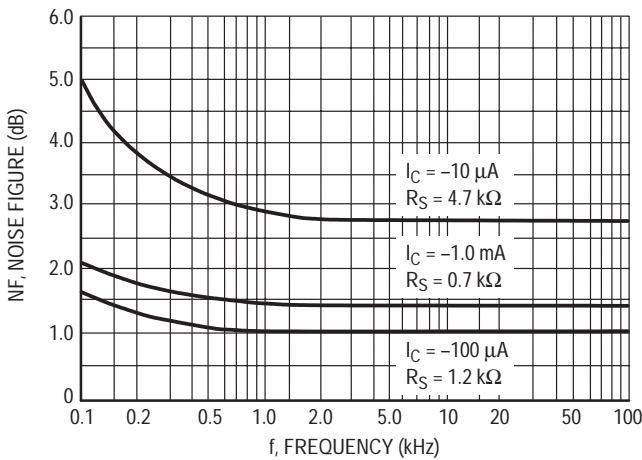

Figure 5. Frequency Effects

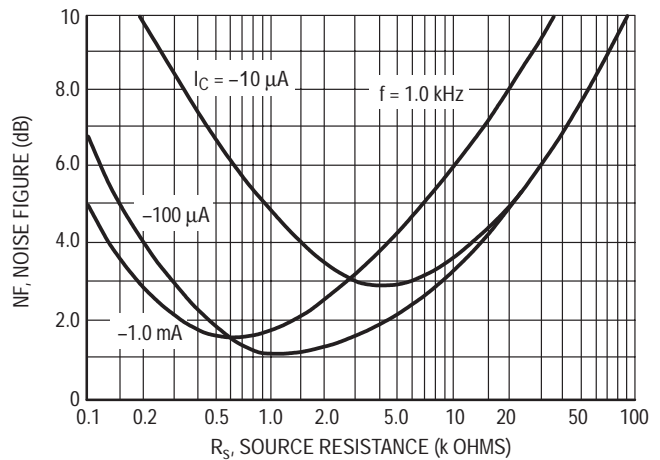

Figure 6. Source Resistance Effects

LIFETIME BUY

LAST SHIP 21/03/00
LAST ORDER 23/09/99

h PARAMETERS

$V_{CE} = 10 \text{ Vdc}$, $f = 1.0 \text{ kHz}$, $T_A = 25^\circ\text{C}$

This group of graphs illustrates the relationship between h_{fe} and other "h" parameters for this series of transistors. To obtain these curves, a high-gain and a low-gain unit were selected and the same units were used to develop the correspondingly numbered curves on each graph.

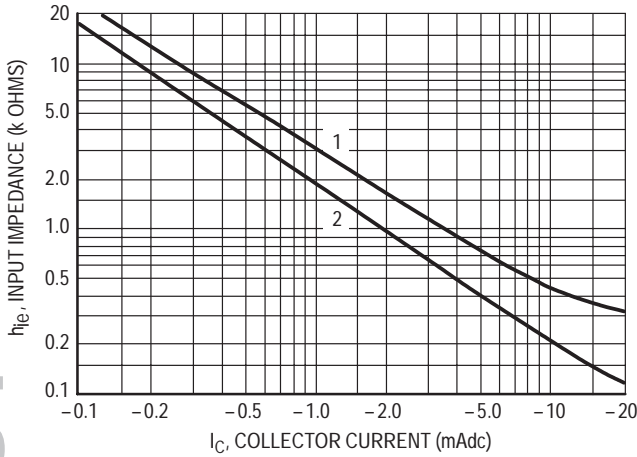

Figure 7. Input Impedance

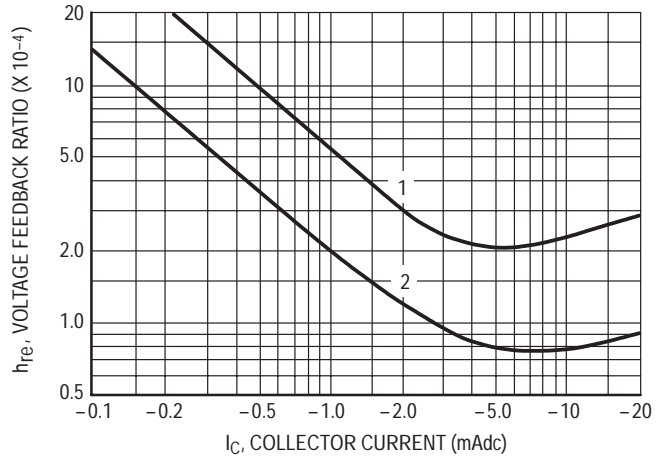

Figure 8. Voltage Feedback Ratio

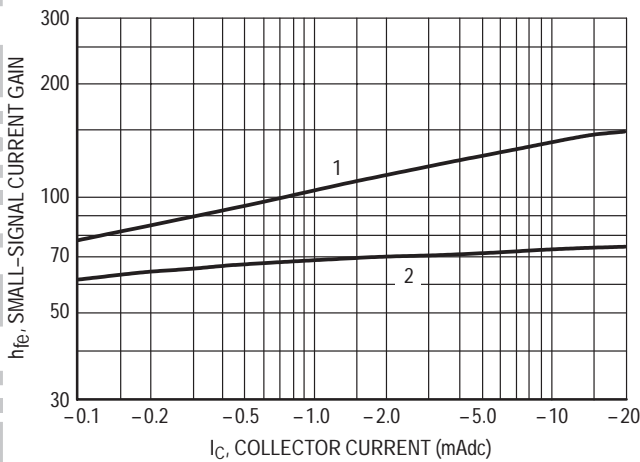

Figure 9. Current Gain

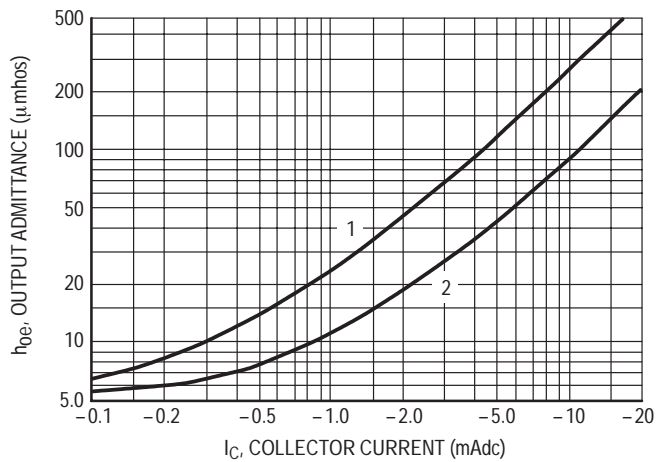

Figure 10. Output Admittance

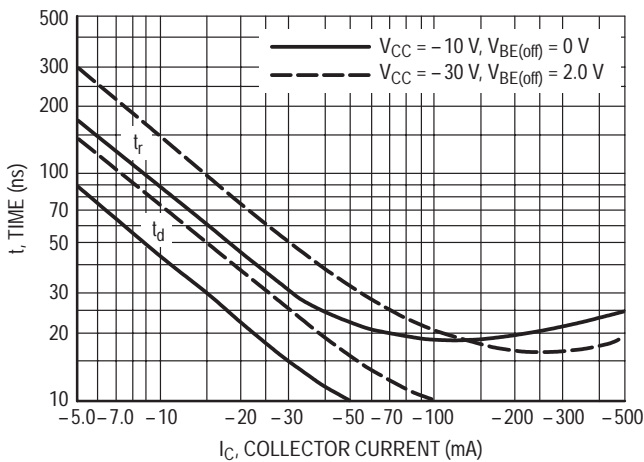

Figure 11. Turn-On Time

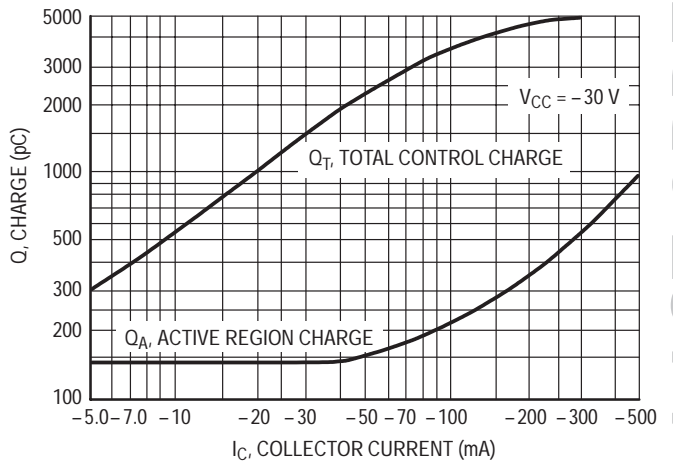

Figure 12. Charge Data

LIFETIME BUY

LAST SHIP 21/03/00
LAST ORDER 23/09/99

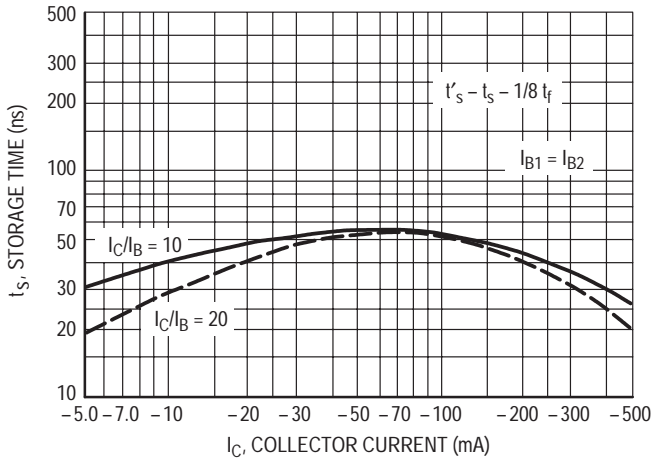

Figure 13. Storage Time

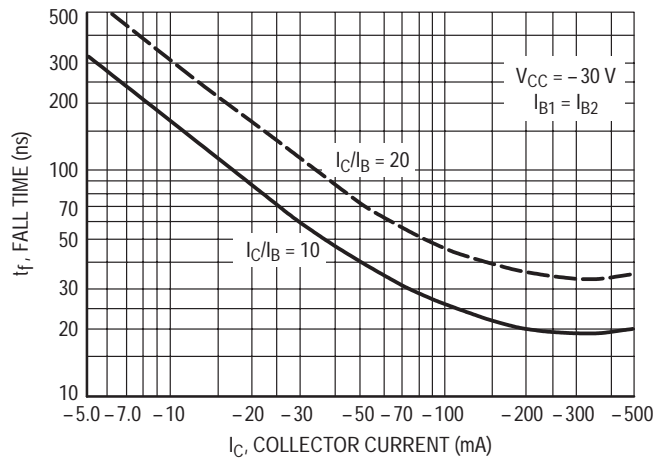

Figure 14. Fall Time

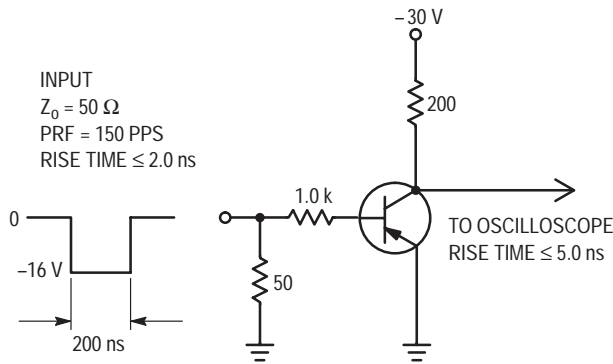

Figure 15a. Delay and Rise Time Test Circuit

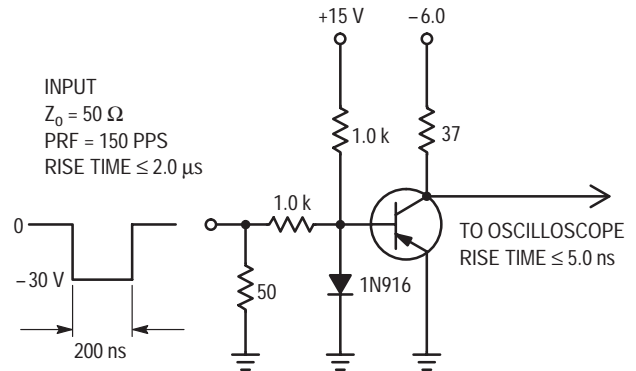

Figure 15b. Storage and Fall Time Test Circuit

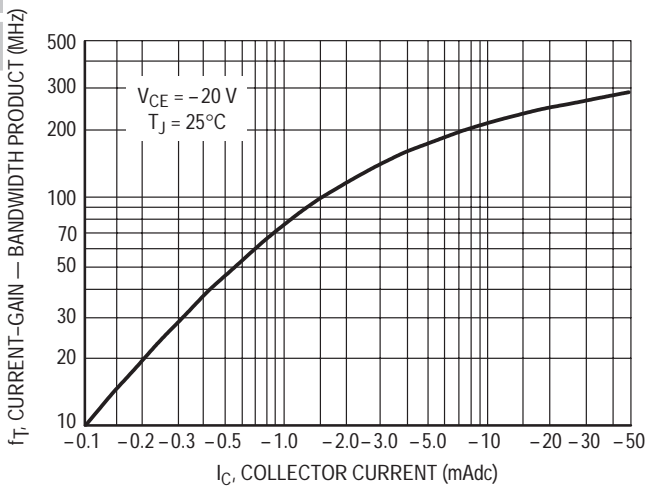

Figure 16. Current-Gain — Bandwidth Product

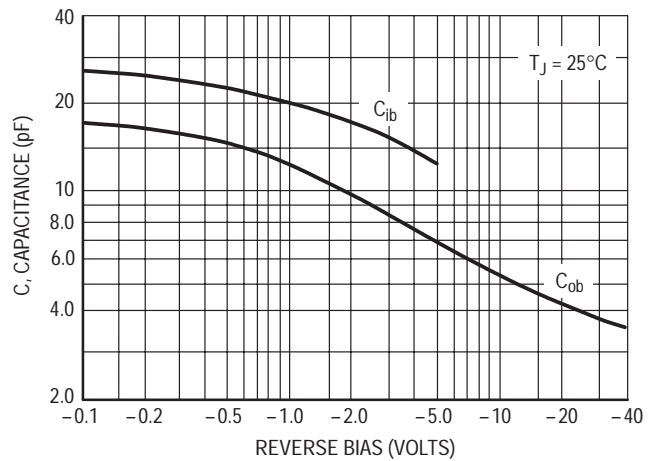

Figure 17. Capacitances

LIFETIME BUY

LAST SHIP 21/03/00
LAST ORDER 23/09/99

2N2904A thru 2N2907,A

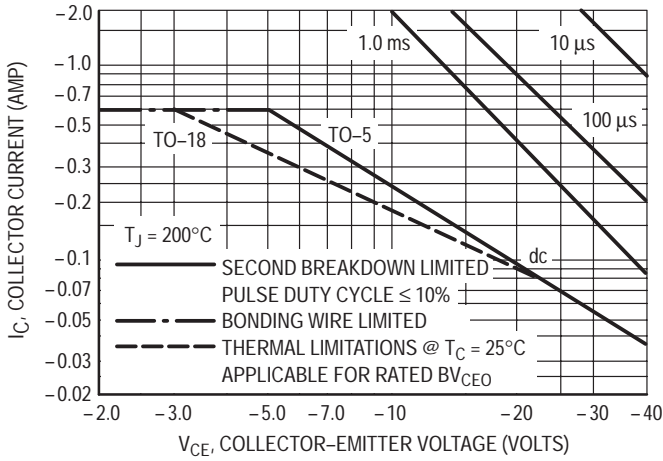

Figure 18. Active Region Safe Operating Areas

This graph shows the maximum I_C - V_{CE} limits of the device both from the standpoint of thermal dissipation (at 25°C case temperature), and secondary breakdown. For case temperatures other than 25°C , the thermal dissipation curve must be modified in accordance with the derating factor in the Maximum Ratings table.

To avoid possible device failure, the collector load line must fall below the limits indicated by the applicable curve. Thus, for certain operating conditions the device is thermally limited, and for others it is limited by secondary breakdown.

For pulse applications, the maximum I_C - V_{CE} product indicated by the dc thermal limits can be exceeded. Pulse thermal limits may be calculated by using the transient thermal resistance curve of Figure 19.

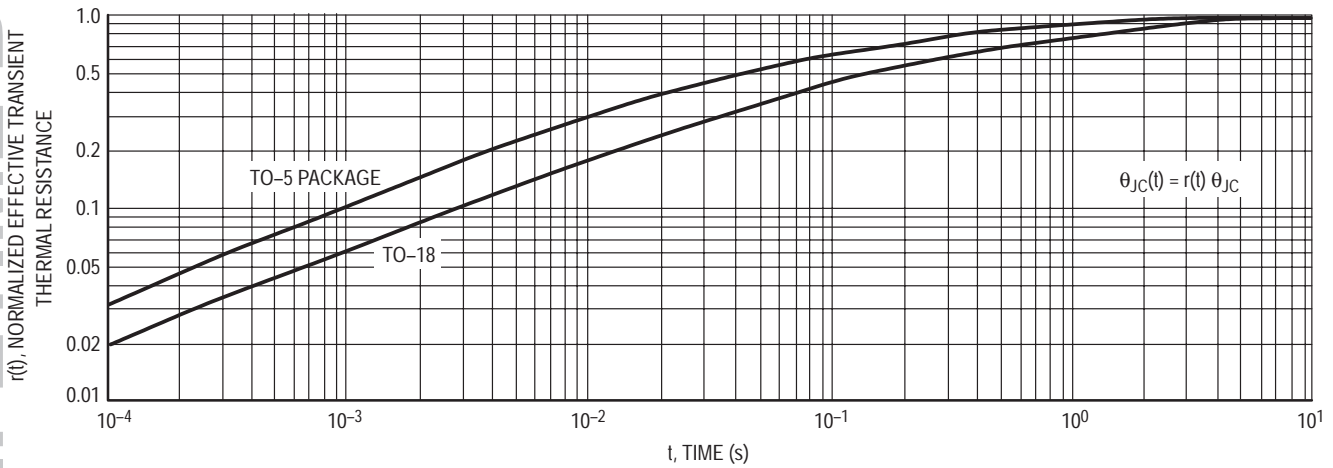
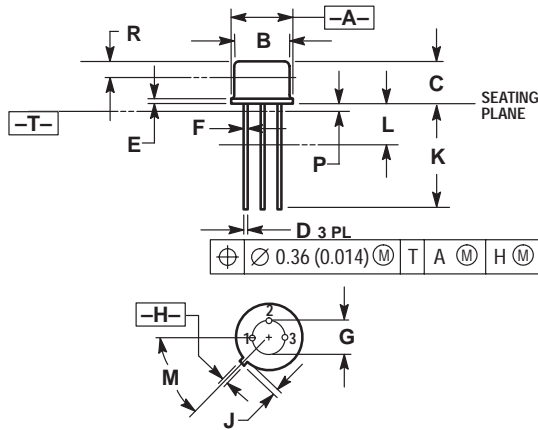

Figure 19. Thermal Resistance

LIFETIME BUY

LAST SHIP 21/03/00
LAST ORDER 23/09/99

PACKAGE DIMENSIONS



- NOTES:
1. DIMENSIONING AND TOLERANCING PER ANSI Y14.5M, 1982.
 2. CONTROLLING DIMENSION: INCH.
 3. DIMENSION J MEASURED FROM DIMENSION A MAXIMUM.
 4. DIMENSION B SHALL NOT VARY MORE THAN 0.25 (0.010) IN ZONE R. THIS ZONE CONTROLLED FOR AUTOMATIC HANDLING.
 5. DIMENSION F APPLIES BETWEEN DIMENSION P AND L. DIMENSION D APPLIES BETWEEN DIMENSION L AND K MINIMUM. LEAD DIAMETER IS UNCONTROLLED IN DIMENSION P AND BEYOND DIMENSION K MINIMUM.

DIM	INCHES		MILLIMETERS	
	MIN	MAX	MIN	MAX
A	0.335	0.370	8.51	9.39
B	0.305	0.335	7.75	8.50
C	0.240	0.260	6.10	6.60
D	0.016	0.021	0.41	0.53
E	0.009	0.041	0.23	1.04
F	0.016	0.019	0.41	0.48
G	0.200 BSC		5.08 BSC	
H	0.028	0.034	0.72	0.86
J	0.029	0.045	0.74	1.14
K	0.500	0.750	12.70	19.05
L	0.250	---	6.35	---
M	45° BSC		45° BSC	
P	---	0.050	---	1.27
R	0.100	---	2.54	---

- STYLE 1:
 PIN 1. EMITTER
 2. BASE
 3. COLLECTOR

CASE 079-04
(TO-205AD)
ISSUE N

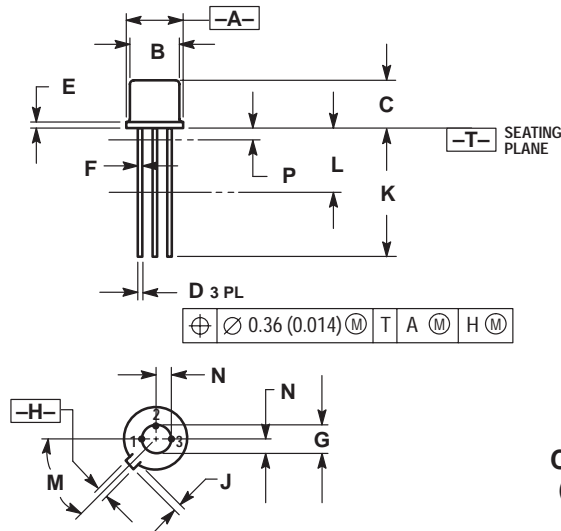

- NOTES:
1. DIMENSIONING AND TOLERANCING PER ANSI Y14.5M, 1982.
 2. CONTROLLING DIMENSION: INCH.
 3. DIMENSION J MEASURED FROM DIMENSION A MAXIMUM.
 4. DIMENSION F APPLIES BETWEEN DIMENSION P AND L. DIMENSION D APPLIES BETWEEN DIMENSION L AND K MINIMUM. LEAD DIAMETER IS UNCONTROLLED IN DIMENSION P AND BEYOND DIMENSION K MINIMUM.
 5. DIMENSION E INCLUDES THE TAB THICKNESS. (TAB THICKNESS IS 0.51(0.002) MAXIMUM).

DIM	INCHES		MILLIMETERS	
	MIN	MAX	MIN	MAX
A	0.209	0.230	5.31	5.84
B	0.178	0.195	4.52	4.95
C	0.170	0.210	4.32	5.33
D	0.016	0.021	0.406	0.533
E	---	0.030	---	0.762
F	0.016	0.019	0.406	0.483
G	0.100 BSC		2.54 BSC	
H	0.036	0.046	0.914	1.17
J	0.028	0.048	0.711	1.22
K	0.500	---	12.70	---
L	0.250	---	6.35	---
M	45° BSC		45° BSC	
N	0.050 BSC		1.27 BSC	
P	---	0.050	---	1.27

- STYLE 1:
 PIN 1. EMITTER
 2. BASE
 3. COLLECTOR

CASE 022-03
(TO-206AA)
ISSUE N

LIFETIME BUY

LAST SHIP 21/03/00
LAST ORDER 23/09/99

LIFETIME BUY

LAST ORDER 23/09/99 LAST SHIP 21/03/00

Motorola reserves the right to make changes without further notice to any products herein. Motorola makes no warranty, representation or guarantee regarding the suitability of its products for any particular purpose, nor does Motorola assume any liability arising out of the application or use of any product or circuit, and specifically disclaims any and all liability, including without limitation consequential or incidental damages. "Typical" parameters which may be provided in Motorola data sheets and/or specifications can and do vary in different applications and actual performance may vary over time. All operating parameters, including "Typicals" must be validated for each customer application by customer's technical experts. Motorola does not convey any license under its patent rights nor the rights of others. Motorola products are not designed, intended, or authorized for use as components in systems intended for surgical implant into the body, or other applications intended to support or sustain life, or for any other application in which the failure of the Motorola product could create a situation where personal injury or death may occur. Should Buyer purchase or use Motorola products for any such unintended or unauthorized application, Buyer shall indemnify and hold Motorola and its officers, employees, subsidiaries, affiliates, and distributors harmless against all claims, costs, damages, and expenses, and reasonable attorney fees arising out of, directly or indirectly, any claim of personal injury or death associated with such unintended or unauthorized use, even if such claim alleges that Motorola was negligent regarding the design or manufacture of the part. Motorola and are registered trademarks of Motorola, Inc. Motorola, Inc. is an Equal Opportunity/Affirmative Action Employer.

How to reach us:

USA/EUROPE: Motorola Literature Distribution;
P.O. Box 20912; Phoenix, Arizona 85036. 1-800-441-2447

JAPAN: Nippon Motorola Ltd.; Tatsumi-SPD-JLDC, Toshikatsu Otsuki,
6F Seibu-Butsuryu-Center, 3-14-2 Tatsumi Koto-Ku, Tokyo 135, Japan. 03-3521-8315

MFAX: RMFAX0@email.sps.mot.com - TOUCHTONE (602) 244-6609
INTERNET: http://Design-NET.com

HONG KONG: Motorola Semiconductors H.K. Ltd.; 8B Tai Ping Industrial Park,
51 Ting Kok Road, Tai Po, N.T., Hong Kong. 852-26629298

